

1994 KDX200 PARTS DIAGRAM

Engine Cover(s)

E1431

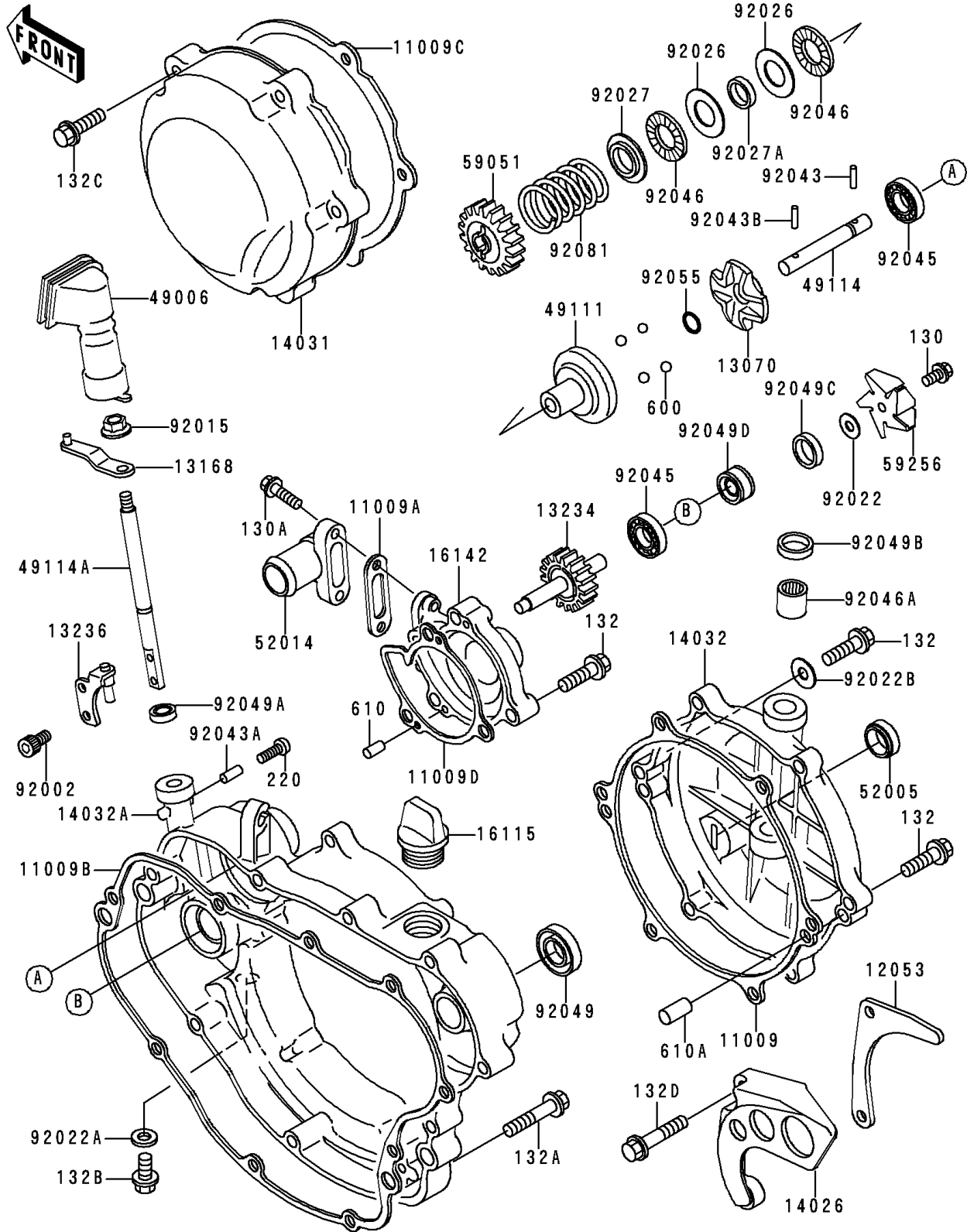

1994 KDX200 PARTS LIST

Engine Cover(s)

ITEM NAME	PART NUMBER	QUANTITY
GASKET,RELESASE COVER (Ref # 11009)	11009-1939	1
GASKET,ELBOW (Ref # 11009A)	11009-1952	1
GASKET,CLUTCH COVER (Ref # 11009B)	11009-1996	1
GASKET,GENERATOR COVER (Ref # 11009C)	11009-1997	1
GASKET,WATER PUMP COVER (Ref # 11009D)	11009-1998	1
GUIDE-CHAIN (Ref # 12053)	12053-1228	1
GUIDE (Ref # 13070)	13070-1122	1
LEVER,GOVERNOR (Ref # 13168)	13168-1371	1
SHAFT-COMP,PUMP (Ref # 13234)	13234-1092	1
LEVER-COMP,GOVERNOR SHAFT (Ref # 13236)	13236-1190	1
COVER-CHAIN (Ref # 14026)	14026-1159	1
COVER-GENERATOR (Ref # 14031)	14031-1231	1
COVER-CLUTCH (Ref # 14032)	14032-1266	1
COVER-CLUTCH (Ref # 14032A)	14032-1296	1
CAP-OIL FILLER (Ref # 16115)	16115-018	1
COVER-PUMP (Ref # 16142)	16142-1090	1
BOOT,GOVERNOR (Ref # 49006)	49006-1228	1
HOLDER-GOVERNOR WEIGHT (Ref # 49111)	49111-1051	1
SHAFT-GOVERNOR (Ref # 49114)	49114-1058	1
SHAFT-GOVERNOR (Ref # 49114A)	49114-1067	1
GAUGE,OIL LEVEL (Ref # 52005)	52005-1055	1
ELBOW (Ref # 52014)	52014-1067	1
GEAR-SPUR,GOVERNOR,18T (Ref # 59051)	59051-1189	1
IMPELLER (Ref # 59256)	59256-1067	1
BOLT,SOCKET,4X8 (Ref # 92002)	92002-1403	2
NUT,6MM (Ref # 92015)	92015-1572	1
WASHER,5.2X13X1 (Ref # 92022)	92022-1380	1
WASHER,8.2X14X1.0 (Ref # 92022A)	92022-1488	1
WASHER,6.2X11X1 (Ref # 92022B)	92022-304	1

1994 KDX200 PARTS LIST

Engine Cover(s)

ITEM NAME	PART NUMBER	QUANTITY
SPACER,15X28X1 (Ref # 92026)	92026-1238	2
COLLAR (Ref # 92027)	92027-1838	1
COLLAR,15.2X17X4 (Ref # 92027A)	92027-1839	1
PIN,3X12.8 (Ref # 92043)	92043-1256	1
PIN,2X9.8 (Ref # 92043A)	92043-1293	1
PIN,3X19.8 (Ref # 92043B)	92043-1319	1
BEARING-BALL,608MC3 (Ref # 92045)	92045-1305	2
BEARING-NEEDLE,AXK1102 (Ref # 92046)	92046-1052	2
BEARING-NEEDLE (Ref # 92046A)	92046-1230	1
SEAL-OIL,SB18307 (Ref # 92049)	92049-013	1
SEAL-OIL,SDO8144 (Ref # 92049A)	92049-1207	1
BOLT-FLANGED (Ref # 130)	130P0510	1
BOLT-FLANGED (Ref # 130A)	130P0520	2
BOLT-FLANGED-SMALL (Ref # 132)	132G0625	9
BOLT-FLANGED-SMALL (Ref # 132A)	132G0630	9
BOLT-FLANGED-SMALL (Ref # 132B)	132G0810	1
BOLT-FLANGED-SMALL (Ref # 132C)	132Y0625	5
BOLT-FLANGED-SMALL (Ref # 132D)	132Y0640	2
SCREW-PAN-CROS (Ref # 220)	220B0306	1
BALL-STEEL,5/16" (Ref # 600)	600A1000	4
ROLLER,4X8 (Ref # 610)	610A0408	2
ROLLER,6X12 (Ref # 610A)	610A0612	2
SEAL-OIL (Ref # 92049B)	92049-1262	1
SEAL-OIL,MH8X18X3.5-A (Ref # 92049C)	92049-1359	1
SEAL-OIL,MHSD8X18X10J-1 (Ref # 92049D)	92049-1366	1
RING-O,5.5X1.5 (Ref # 92055)	92055-1343	1
SPRING,GOVERNOR (Ref # 92081)	92081-1769	1