

2000 Ninja® ZX™-9R PARTS DIAGRAM

Gear Change Mechanism

E1370

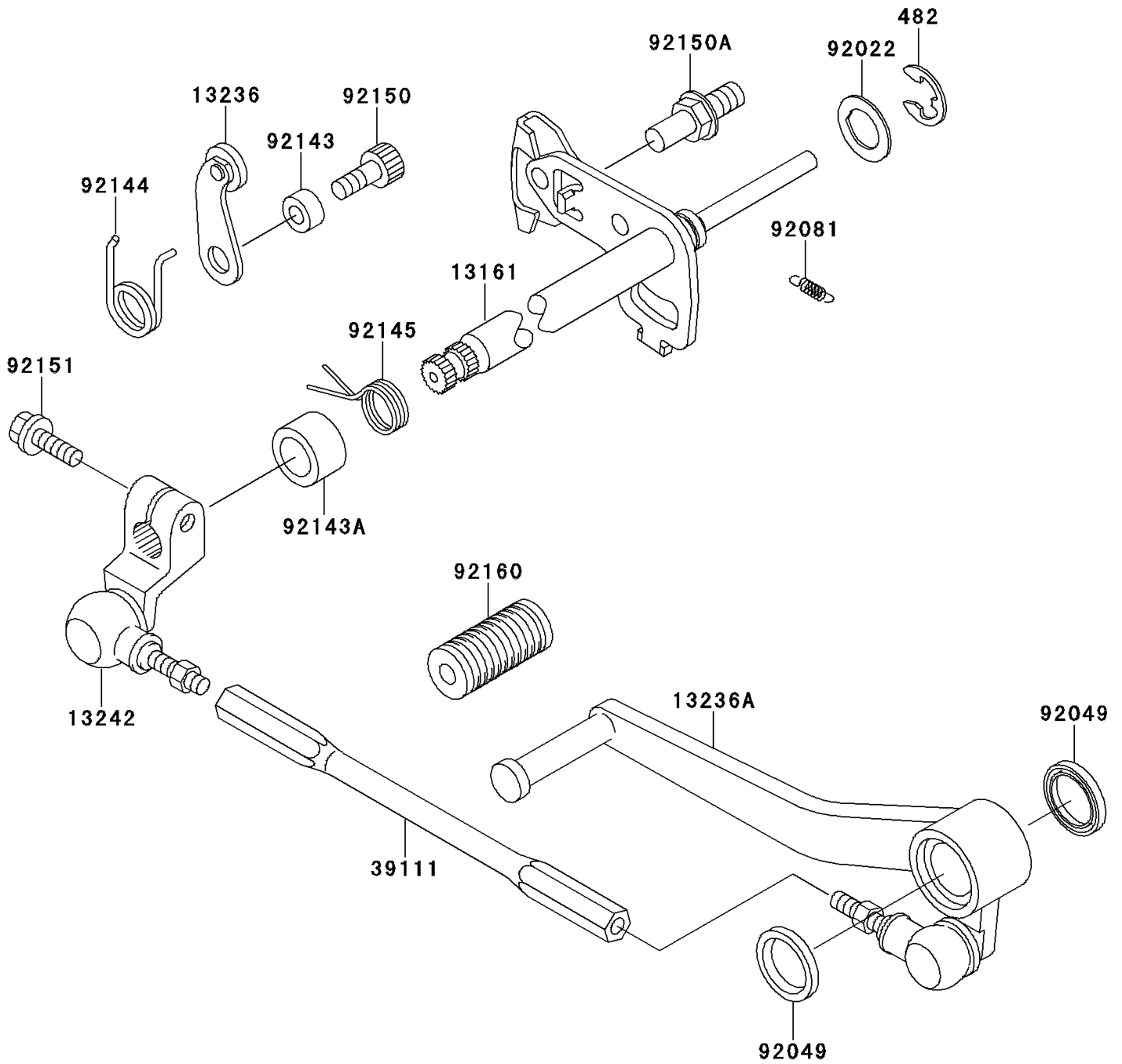

2000 Ninja® ZX™-9R PARTS LIST

Gear Change Mechanism

ITEM NAME	PART NUMBER	QUANTITY
CIRCLIP-TYPE-E,12MM (Ref # 482)	482J0200	1
LEVER-COMP-CHANGE SHAFT (Ref # 13161)	13161-1246	1
LEVER-COMP (Ref # 13236)	13236-1243	1
LEVER-COMP,CHANGE PEDAL (Ref # 13236A)	13236-1317	1
LEVER-ASSY-CHANGE,BOSS (Ref # 13242)	13242-1348	1
ROD-TIE (Ref # 39111)	39111-1157	1
WASHER,CHANGE SHAFT (Ref # 92022)	92022-1628	1
SEAL-OIL (Ref # 92049)	92049-1492	2
SPRING,PAWL RETURN (Ref # 92081)	92081-1708	1
COLLAR (Ref # 92143)	92143-1595	1
COLLAR,13.2X19.9X12 (Ref # 92143A)	92143-1733	1
SPRING (Ref # 92144)	92144-1856	1
SPRING (Ref # 92145)	92145-1122	1
BOLT,SOCKET,6X16 (Ref # 92150)	92150-1737	1
BOLT,RETURN SPRING (Ref # 92150A)	92150-1869	1
BOLT,6X20 (Ref # 92151)	92151-1226	1
DAMPER,CHANGE PEDAL (Ref # 92160)	92160-1036	1