

# 2025 Ninja ZX-4R ABS PARTS DIAGRAM

Stand(s)

F2190

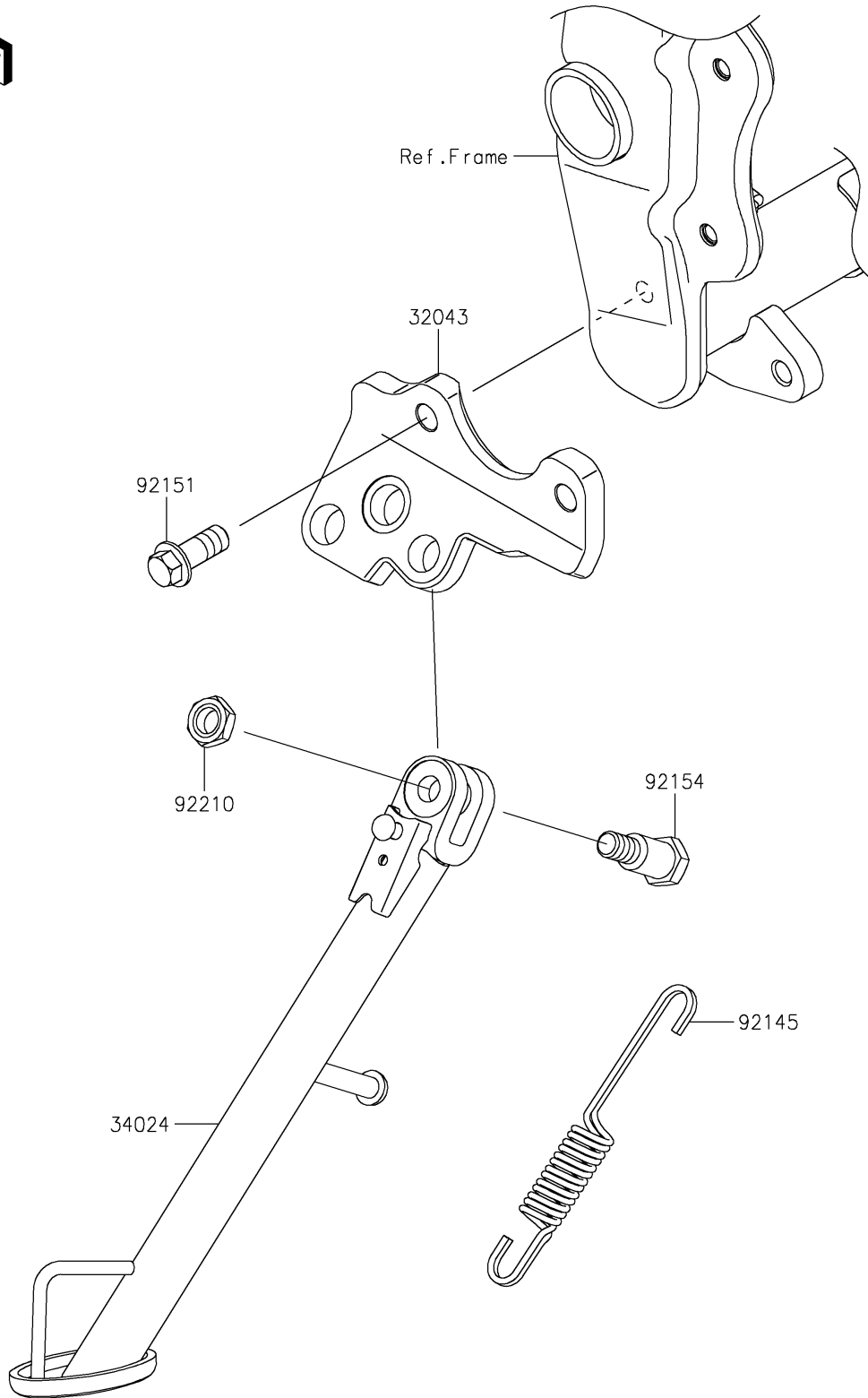

## 2025 Ninja ZX-4R ABS PARTS LIST

Stand(s)

ITEM NAME	PART NUMBER	QUANTITY
BRACKET-STAND (Ref # 32043)	32043-0668	1
STAND-SIDE (Ref # 34024)	34024-0138	1
SPRING,SIDE STAND (Ref # 92145)	92145-0804	1
BOLT,FLANGED,10X25 (Ref # 92151)	92151-1802	2
BOLT,10X35.5 (Ref # 92154)	92154-1023	1
NUT,LOCK,10MM (Ref # 92210)	92210-0784	1