

# 1994 Ninja® ZX™ -9R PARTS DIAGRAM

Chassis Electrical Equipment

F2760

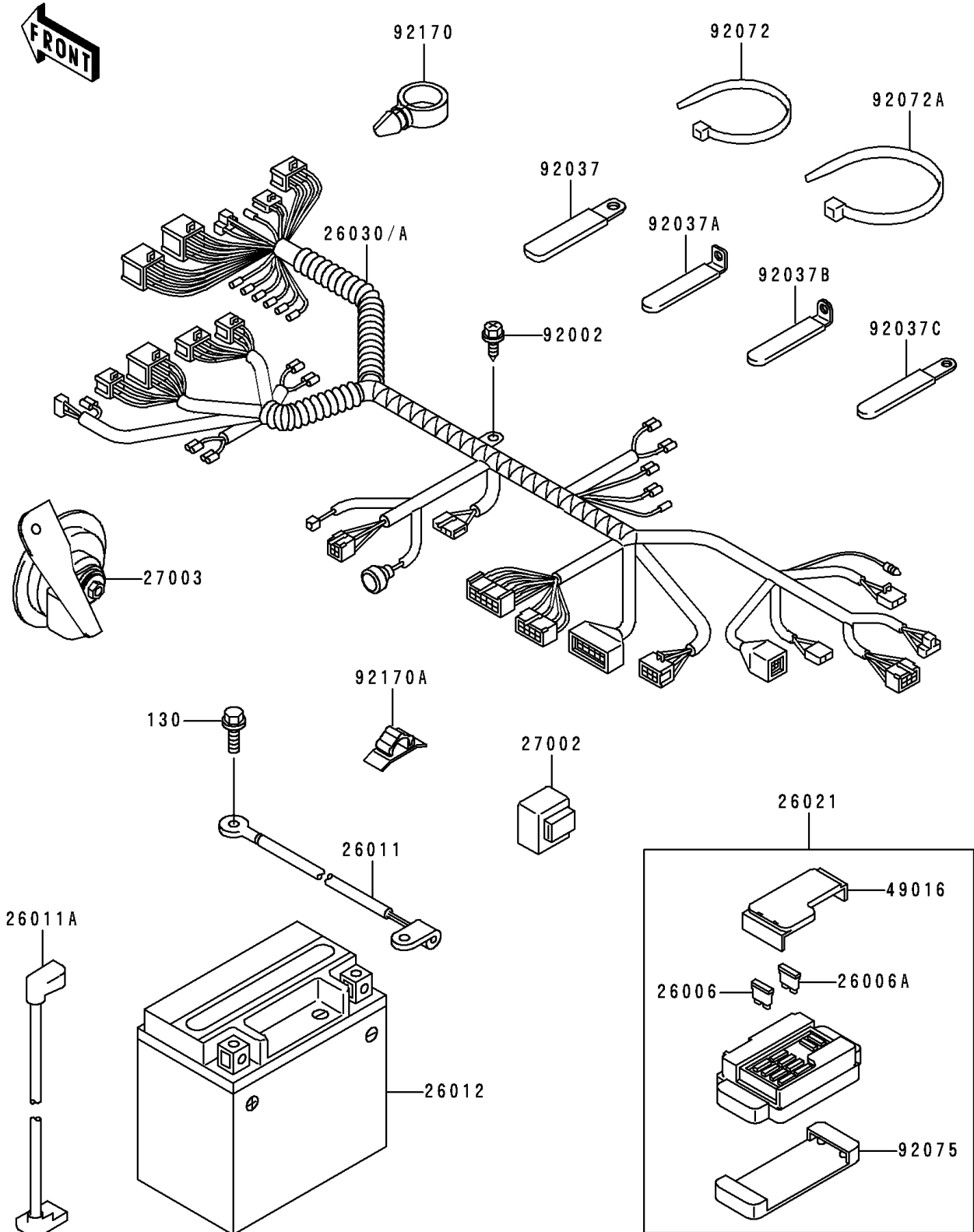

# 1994 Ninja® ZX™-9R PARTS LIST

## Chassis Electrical Equipment

ITEM NAME	PART NUMBER	QUANTITY
BOLT-FLANGED,6X10 (Ref # 130)	130G0610	1
FUSE,30A-G (Ref # 26006)	26006-1067	1
FUSE,10A-R (Ref # 26006A)	26006-1068	8
WIRE-LEAD,BATTERY(-) (Ref # 26011)	26011-1429	1
WIRE-LEAD,BATTERY(+) (Ref # 26011A)	26011-1584	1
BATTERY,YTX12-BS,12V 10AH (Ref # 26012)	26012-1281	1
JUNCTION BOX (Ref # 26021)	26021-1089	1
HARNESS,MAIN (Ref # 26030)	26030-1243	1
RELAY-ASSY,TURN SIGNAL (Ref # 27002)	27002-1053	1
HORN (Ref # 27003)	27003-1373	1
COVER-SEAL,FUSE (Ref # 49016)	49016-1177	1
BOLT,TAPPING,5X16 (Ref # 92002)	92002-1472	1
CLAMP,WIRING HARNESS (Ref # 92037)	92037-1069	3
CLAMP,HARNESS (Ref # 92037A)	92037-1316	1
CLAMP (Ref # 92037B)	92037-1679	2
CLAMP (Ref # 92037C)	92037-1993	1
BAND,L=185 (Ref # 92072)	92072-1195	9
BAND,L=365 (Ref # 92072A)	92072-1197	2
DAMPER,JUNCTION BOX (Ref # 92075)	92075-1688	1
CLAMP (Ref # 92170)	92170-1067	3
CLAMP,HARNESS (Ref # 92170A)	92170-1494	1