

1994 Ninja® ZX™ -9R PARTS DIAGRAM

Battery Case

F2132

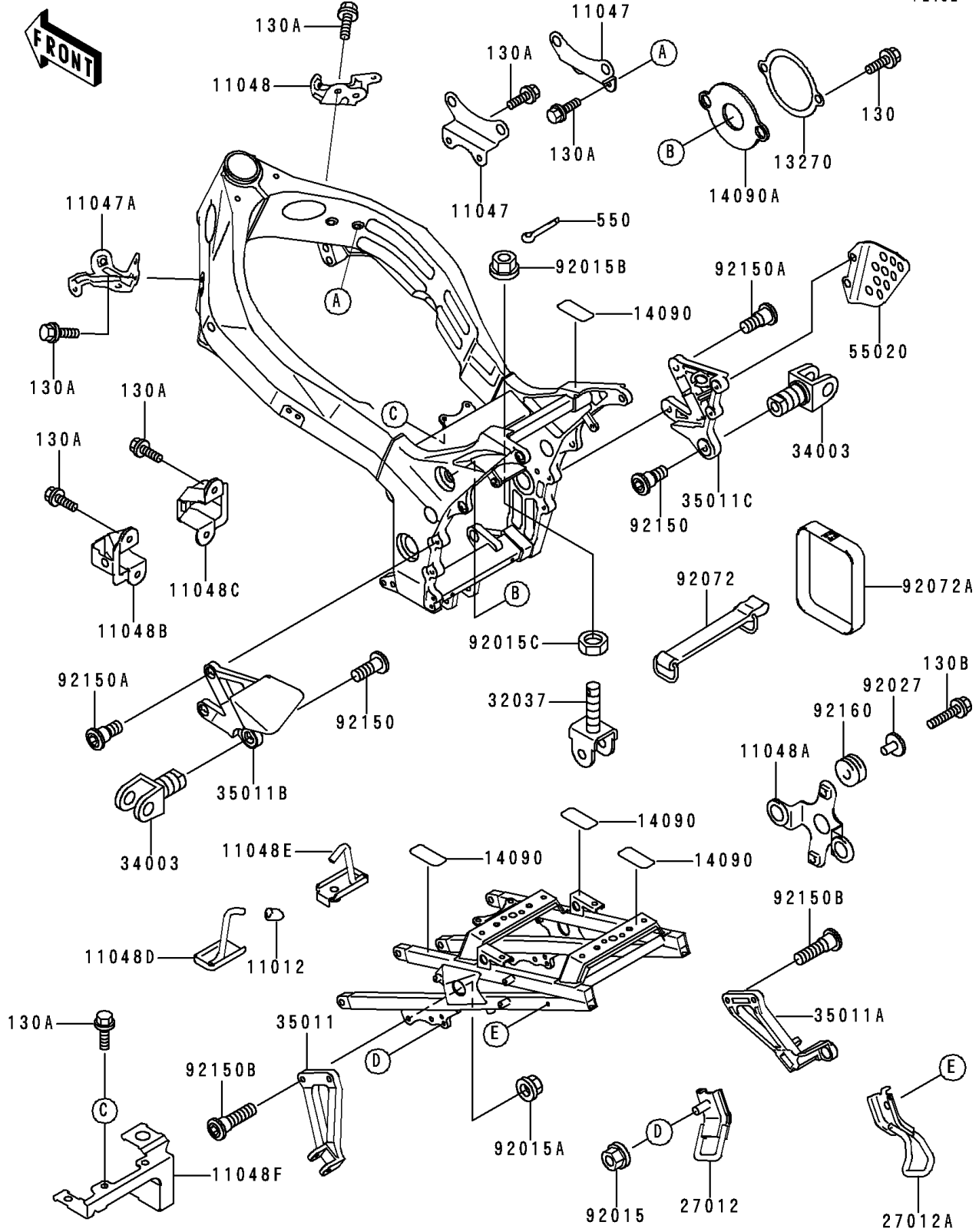

1994 Ninja® ZX™-9R PARTS LIST

Battery Case

ITEM NAME	PART NUMBER	QUANTITY
BOLT-FLANGED (Ref # 130)	130J0610	2
BOLT-FLANGED,6X16,BLACK (Ref # 130A)	130J0616	14
BOLT-FLANGED,6X25 (Ref # 130B)	130J0625	2
PIN-COTTER,4.0X25 (Ref # 550)	550D4025	1
CAP,BUNGEE CORD HOOK (Ref # 11012)	11012-1589	2
BRACKET,IGNITION COIL (Ref # 11047)	11047-1345	2
BRACKET,RADIATOR,LH (Ref # 11047A)	11047-1853	1
BRACKET,RADIATOR,RH (Ref # 11048)	11048-1357	1
BRACKET,IGNITER (Ref # 11048A)	11048-1683	1
BRACKET,LWR COWLING,LH (Ref # 11048B)	11048-1777	1
BRACKET,LWR COWLING,RH (Ref # 11048C)	11048-1780	1
BRACKET,HELMET HOOK,LH (Ref # 11048D)	11048-1793	1
BRACKET,HELMET HOOK,RH (Ref # 11048E)	11048-1795	1
BRACKET,FUEL PUMP&FILTER (Ref # 11048F)	11048-1796	1
PLATE,FUEL TAP KNOB (Ref # 13270)	13270-1171	1
COVER (Ref # 14090)	14090-1297	8
COVER,FUEL TAP KNOB (Ref # 14090A)	14090-1410	1
HOOK,BUNGEE CORD,FR (Ref # 27012)	27012-1474	2
HOOK,BUNGEE CORD,RR (Ref # 27012A)	27012-1475	2
BRACKET-SHOCKABSORBER (Ref # 32037)	32037-1657	1
HOLDER-STEP (Ref # 34003)	34003-1327	2
STAY,RR,LH,G.GRAY (Ref # 35011)	35011-1667-GD	1
STAY,RR,RH,G.GRAY (Ref # 35011A)	35011-1668-GD	1
STAY,FR,LH,G.GRAY (Ref # 35011B)	35011-1699-GD	1
STAY,FR,RH,G.GRAY (Ref # 35011C)	35011-1700-GD	1
GUARD,RR MASTER CYLINDER (Ref # 55020)	55020-1502	1
NUT,FLANGED,6MM (Ref # 92015)	92015-1367	2
NUT,FLANGED,8MM (Ref # 92015A)	92015-1406	4
NUT,FLANGED,16MM (Ref # 92015B)	92015-1881	1

1994 Ninja® ZX™-9R PARTS LIST

Battery Case

ITEM NAME	PART NUMBER	QUANTITY
NUT,16MM (Ref # 92015C)	92015-1953	1
COLLAR,L=14.1 (Ref # 92027)	92027-1920	2
BAND,BATTERY (Ref # 92072)	92072-1306	1
BAND,BATTERY,L=450 (Ref # 92072A)	92072-1309	1
BOLT,SOCKET,10X25 (Ref # 92150)	92150-1268	2
BOLT,SOCKET,8X20 (Ref # 92150A)	92150-1839	4
BOLT,SOCKET,8X30 (Ref # 92150B)	92150-1843	4
DAMPER (Ref # 92160)	92160-1162	2