

## 1997 Ninja® ZX™-7R PARTS DIAGRAM

Rear Brake

F2294

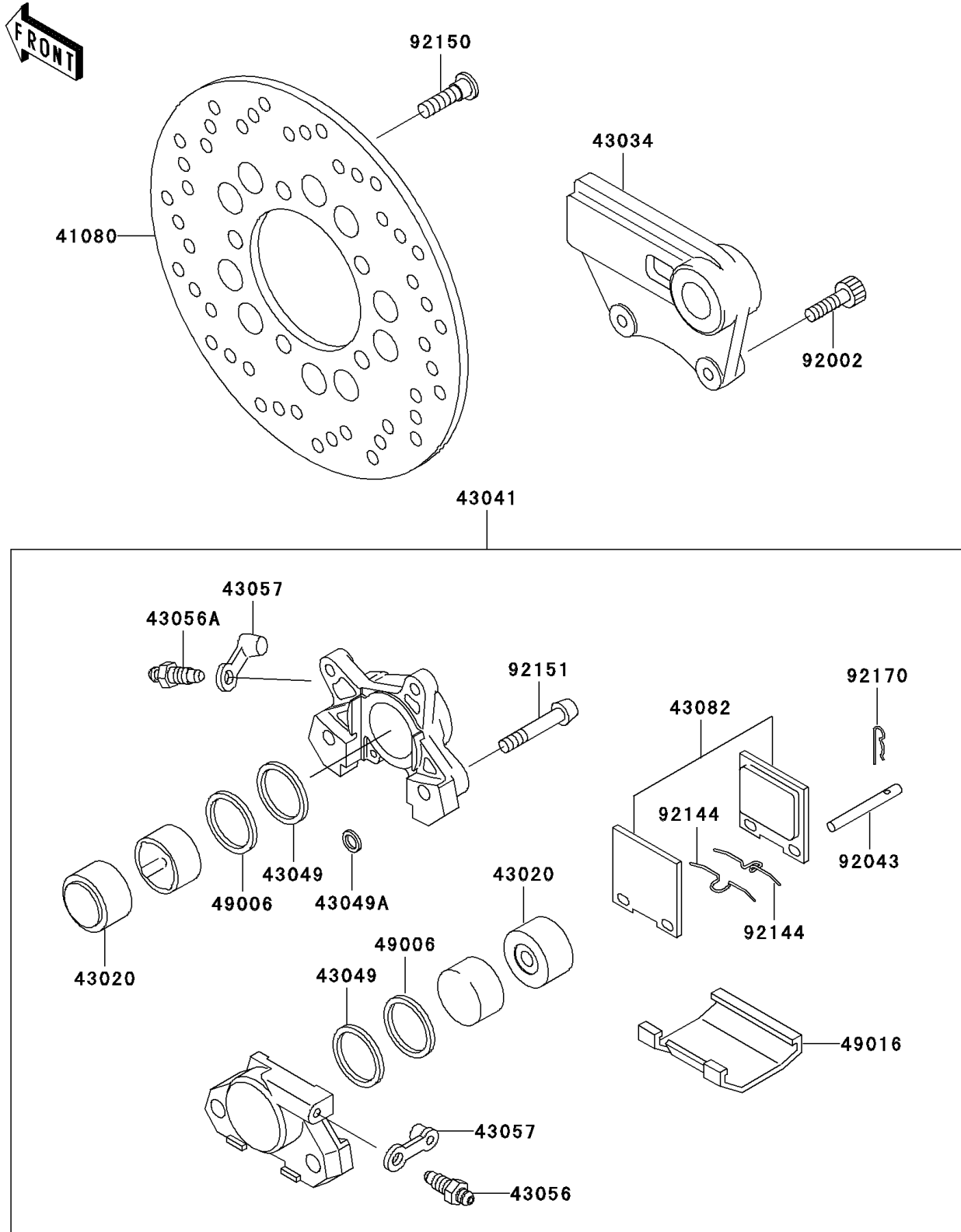

## 1997 Ninja® ZX™-7R PARTS LIST

Rear Brake

ITEM NAME	PART NUMBER	QUANTITY
DISC,RR,C.GRAY (Ref # 41080)	41080-1242-FB	1
PISTON-COMP-BRAKE (Ref # 43020)	43020-1111	1
HOLDER-BRAKE,REAR CALIPER (Ref # 43034)	43034-1137	1
CALIPER-ASSY,RR (Ref # 43041)	43041-1591	1
PACKING,PISTON SEAL (Ref # 43049)	43049-001	1
PACKING,SEAL,6.5X11.5X2.2 (Ref # 43049A)	43049-1004	1
BREATHER (Ref # 43056)	43056-003	1
BREATHER-BRAKE (Ref # 43056A)	43056-1054	1
CAP-BREATHER (Ref # 43057)	43057-003	1
PAD-ASSY-BRAKE (Ref # 43082)	43082-1180	1
BOOT,PISTON SEAL (Ref # 49006)	49006-1212	1
COVER-SEAL (Ref # 49016)	49016-1145	1
BOLT,SOCKET,8X25 (Ref # 92002)	92002-1442	1
PIN (Ref # 92043)	92043-1522	1
SPRING,PAD (Ref # 92144)	92144-1401	1
BOLT,SOCKET,8X30 (Ref # 92150)	92150-1771	1
BOLT,SOCKET,10X45 (Ref # 92151)	92151-1106	1
CLAMP (Ref # 92170)	92170-1635	1