

# 2025 MULE SX™ 4x4 XC PARTS DIAGRAM

Seat

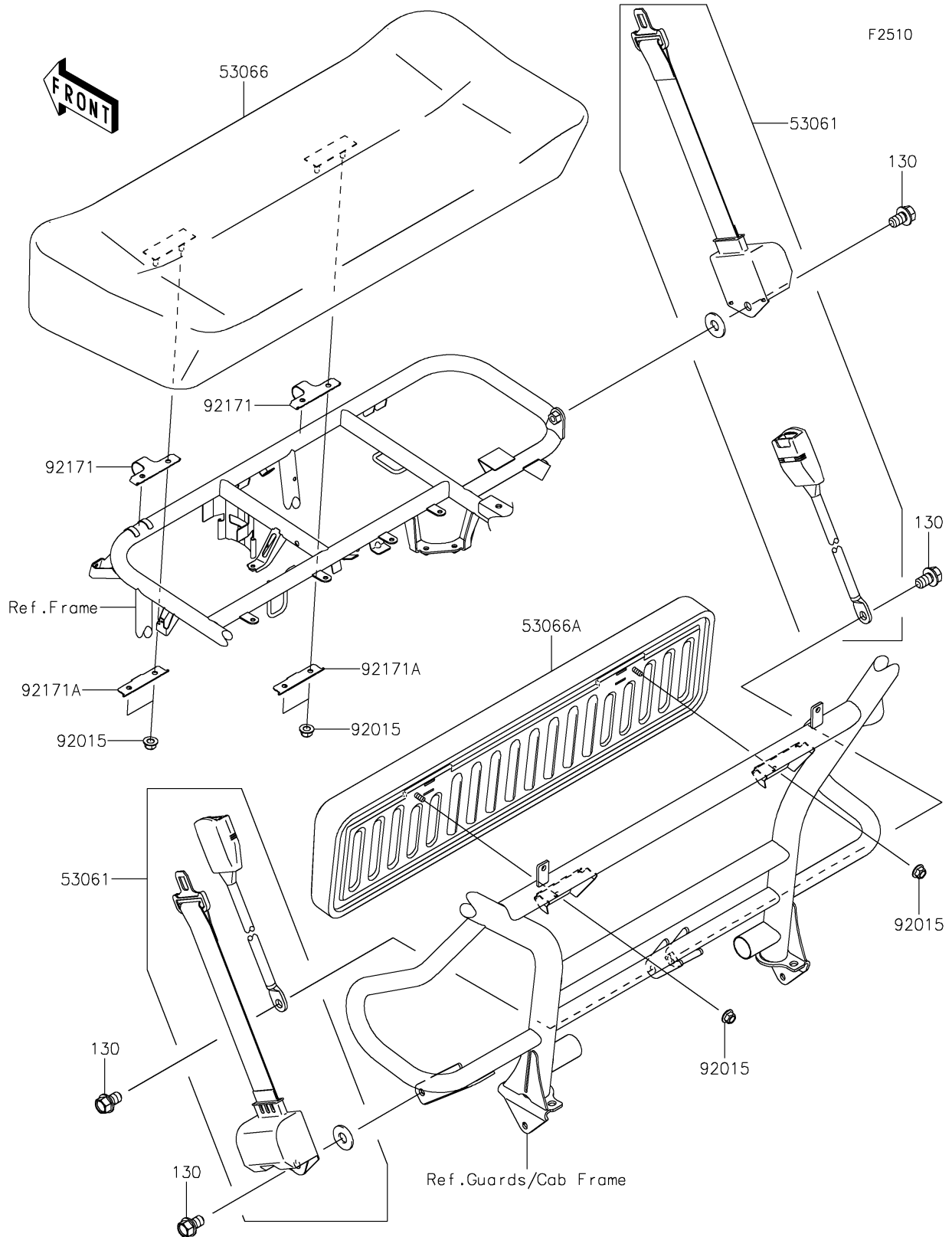

## 2025 MULE SX™ 4x4 XC PARTS LIST

### Seat

ITEM NAME	PART NUMBER	QUANTITY
BELT-SEAT (Ref # 53061)	53061-0050	2
SEAT-ASSY,CUSHION,BLACK (Ref # 53066)	53066-0961-MA	1
SEAT-ASSY,BACK,BLACK (Ref # 53066A)	53066-0962-MA	1
NUT,FLANGED,LOCK,8MM (Ref # 92015)	92015-1668	6
CLAMP (Ref # 92171)	92171-0441	2
CLAMP (Ref # 92171A)	92171-0442	2
BOLT-FLANGED,12X20 (Ref # 130)	130BA1220	4