

2023 TERYX® S LE PARTS DIAGRAM

Reflectors(CN)

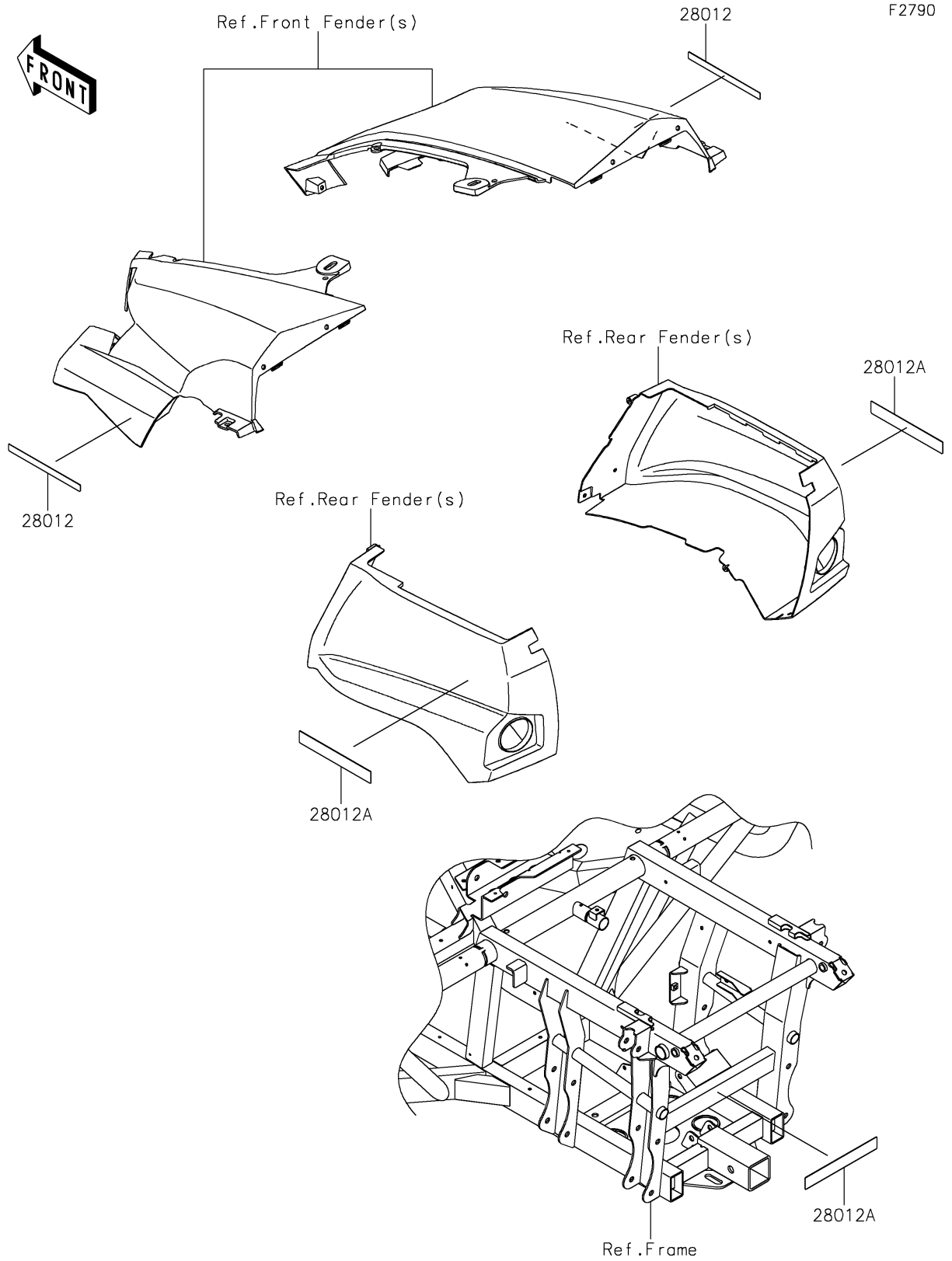

2023 TERYX® S LE PARTS LIST

Reflectors(CN)

ITEM NAME	PART NUMBER	QUANTITY
REFLECTOR-REFLEX,FR (Ref # 28012)	28012-0014	2
REFLECTOR-REFLEX,RR,RED (Ref # 28012A)	28012-0023	3