

2022 MULE SX™ 4x4 FI PARTS DIAGRAM

Cooling

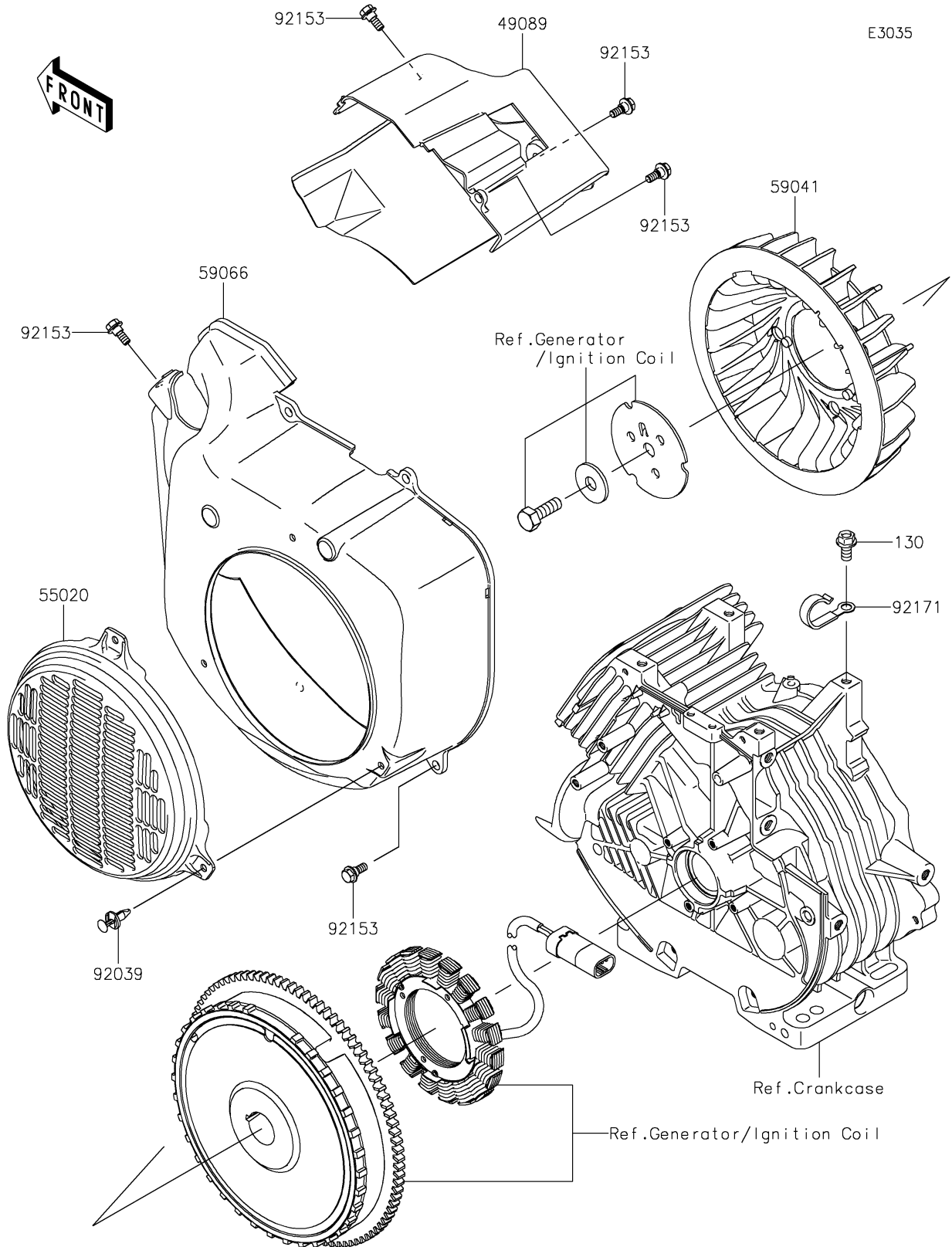

2022 MULE SX™ 4x4 FI PARTS LIST

Cooling

| ITEM NAME | PART NUMBER | QUANTITY |
|---------------------------------|-------------|----------|
| SHROUD-ENGINE (Ref # 49089) | 49089-7089 | 1 |
| GUARD (Ref # 55020) | 55020-2267 | 1 |
| FAN (Ref # 59041) | 59041-0019 | 1 |
| HOUSING-FAN (Ref # 59066) | 59066-7059 | 1 |
| RIVET,GUARD (Ref # 92039) | 92039-0751 | 3 |
| BOLT,FLANGED,6X16 (Ref # 92153) | 92153-7007 | 8 |
| CLAMP (Ref # 92171) | 92171-7005 | 1 |
| BOLT-FLANGED,8X16 (Ref # 130) | 130BA0816 | 1 |