

# 2020 MULE SX™ 4x4 XC CAMO FI PARTS DIAGRAM

Carrier(s)

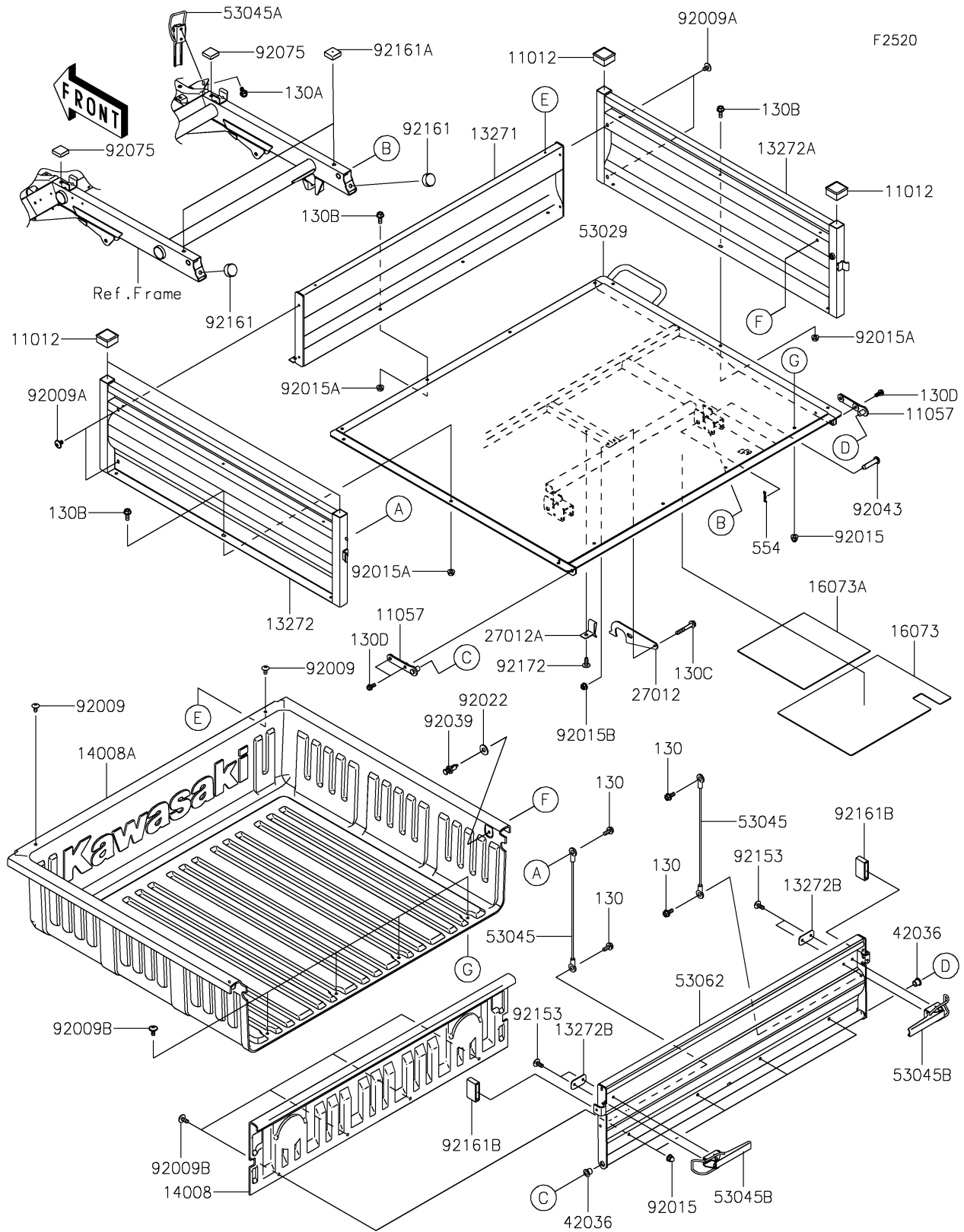

## 2020 MULE SX™ 4x4 XC CAMO FI PARTS LIST

Carrier(s)

ITEM NAME	PART NUMBER	QUANTITY
CAP (Ref # 11012)	11012-1784	4
BRACKET, TAIL GATE (Ref # 11057)	11057-1623	2
PLATE, CARRIER, SIDE, FR, BLACK (Ref # 13271)	13271-0385-10	1
PLATE, SIDE CARRIER, LH, CAMO (Ref # 13272)	13272-2506-42J	1
PLATE, SIDE CARRIER, RH, CAMO (Ref # 13272A)	13272-2507-42J	1
PLATE (Ref # 13272B)	13272-7516	2
LINER, TAILGATE (Ref # 14008)	14008-0019	1
LINER, CARRIER BASE (Ref # 14008A)	14008-0020	1
INSULATOR, 295X400 (Ref # 16073)	16073-0868	1
INSULATOR, 265X265 (Ref # 16073A)	16073-0869	1
HOOK (Ref # 27012)	27012-0044	1
HOOK, CARRIER (Ref # 27012A)	27012-1445	1
SLEEVE (Ref # 42036)	42036-0839	2
CARRIER, BASE, BLACK (Ref # 53029)	53029-0357-10	1
HOOK-ASSY, CABLE (Ref # 53045)	53045-0030	2
HOOK-ASSY (Ref # 53045A)	53045-0032	1
HOOK-ASSY (Ref # 53045B)	53045-0033	2
GATE-TAIL, CAMOUFLAGE (Ref # 53062)	53062-0027-42J	1
SCREW, 6X12 (Ref # 92009)	92009-1480	2
SCREW, 6X10 (Ref # 92009A)	92009-1661	4
SCREW, 6X14 (Ref # 92009B)	92009-1662	8
NUT, LOCK 6MM (Ref # 92015)	92015-1262	8
NUT, FLANGED, 6MM (Ref # 92015A)	92015-1367	10
NUT, LOCK, FLANGED, 6MM (Ref # 92015B)	92015-1675	1
WASHER, 8.5X20X1.6, BLACK (Ref # 92022)	92022-1317	2
RIVET (Ref # 92039)	92039-0776	2
PIN, 12X54 (Ref # 92043)	92043-1451	2
DAMPER (Ref # 92075)	92075-1882	2
BOLT, SOCKET, 6X14 (Ref # 92153)	92153-1021	4

## 2020 MULE SX™ 4x4 XC CAMO FI PARTS LIST

Carrier(s)

ITEM NAME	PART NUMBER	QUANTITY
DAMPER,SEAT (Ref # 92161)	92161-1065	2
DAMPER (Ref # 92161A)	92161-2219	2
DAMPER (Ref # 92161B)	92161-7519	2
SCREW,TAPPING,6X16 (Ref # 92172)	92172-0739	1
BOLT-FLANGED,6X10 (Ref # 130)	130BA0610	4
BOLT-FLANGED,6X14 (Ref # 130A)	130BA0614	2
BOLT-FLANGED,6X16 (Ref # 130B)	130BA0616	10
BOLT-FLANGED,6X40 (Ref # 130C)	130BA0640	1
BOLT-FLANGED,8X20 (Ref # 130D)	130BA0820	4
PIN-SNAP,12MM (Ref # 554)	554DA1200	2