

2025 RIDGE® XR HVAC PARTS DIAGRAM

Battery

F2761

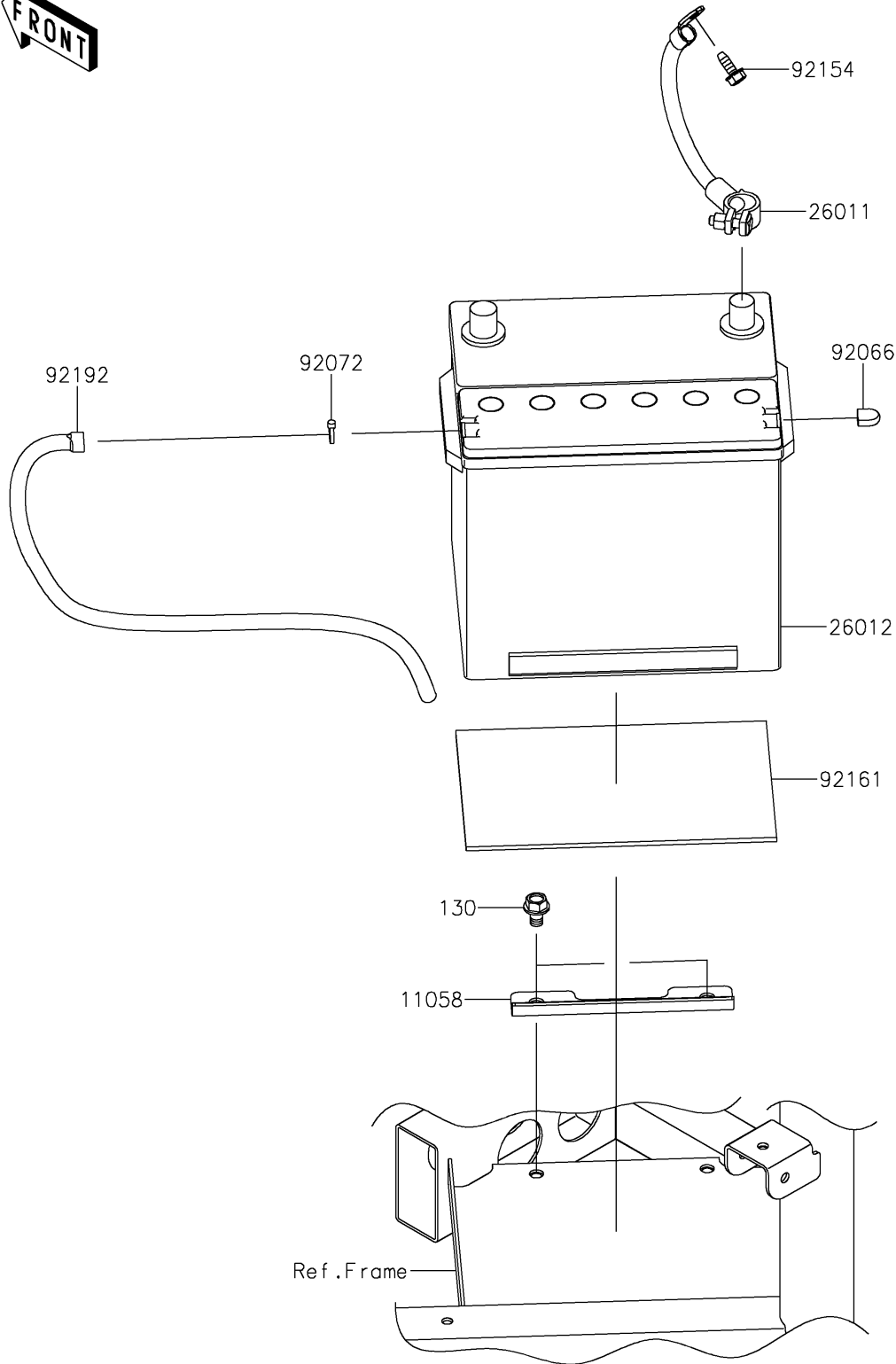

2025 RIDGE® XR HVAC PARTS LIST

Battery

ITEM NAME	PART NUMBER	QUANTITY
BRACKET,BATTERY (Ref # 11058)	11058-0790	1
WIRE-LEAD,BATTERY(-) (Ref # 26011)	26011-1871	1
BATTERY,12V 32AH (Ref # 26012)	26012-0619	1
PLUG,BREATHER (Ref # 92066)	92066-1592	1
BAND,92X2.4 (Ref # 92072)	92072-0791	1
BOLT,FLANGED,6X16 (Ref # 92154)	92154-0551	1
DAMPER (Ref # 92161)	92161-0578	1
TUBE,BREATHER,7X10X450 (Ref # 92192)	92192-1694	1
BOLT-FLANGED,8X12 (Ref # 130)	130BA0812	2