

2025 Ridge HVAC PARTS DIAGRAM

Rear Hubs/Brakes

F2240

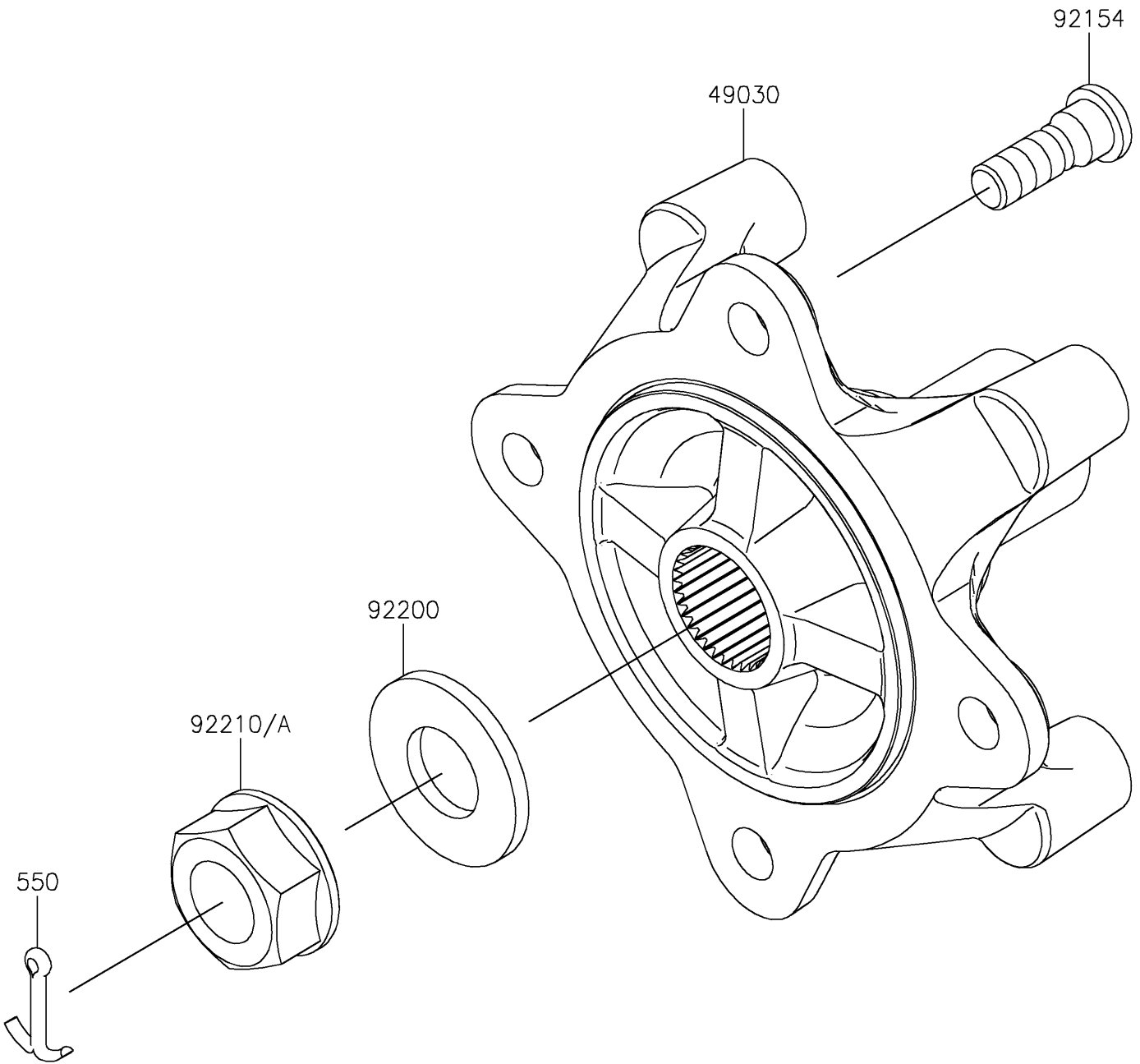

2025 Ridge HVAC PARTS LIST

Rear Hubs/Brakes

ITEM NAME	PART NUMBER	QUANTITY
HUB,RR (Ref # 49030)	49030-0571	2
BOLT,12MM (Ref # 92154)	92154-7074	8
WASHER,24.3X50X4.5 (Ref # 92200)	92200-2610	2
NUT,24MM (Ref # 92210)	92210-1776	1
NUT,24MM,LEFT HANDED (Ref # 92210A)	92210-1780	1
PIN-COTTER,4.0X30 (Ref # 550)	550AA4030	2