

2024 Ninja ZX-14R ABS SE PARTS DIAGRAM

Crankcase

E1411

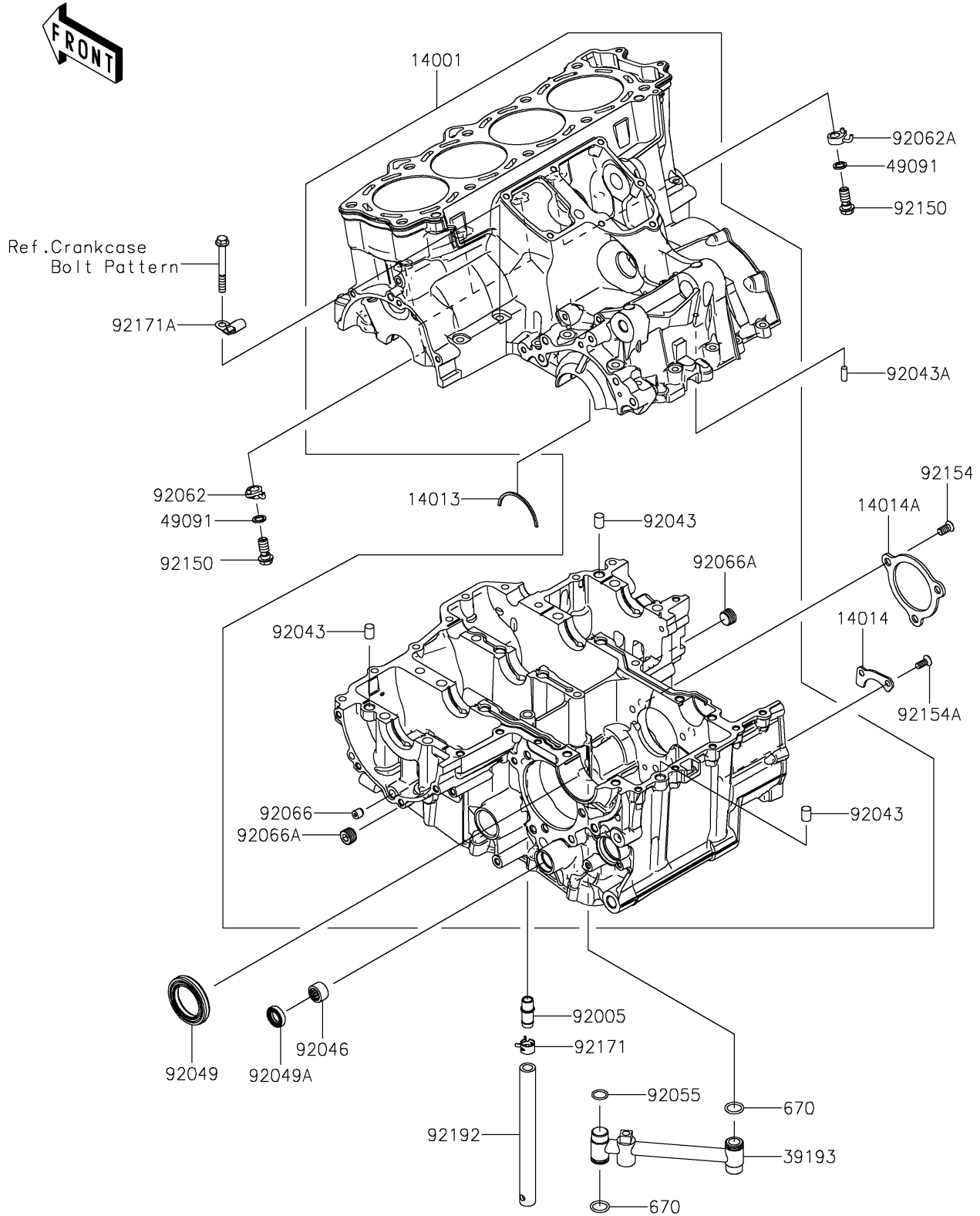

2024 Ninja ZX-14R ABS SE PARTS LIST

Crankcase

ITEM NAME	PART NUMBER	QUANTITY
SET-CRANKCASE (Ref # 14001)	14001-0653	1
RING-POSITION (Ref # 14013)	14013-1051	1
PLATE-POSITION (Ref # 14014)	14014-0023	1
PLATE-POSITION (Ref # 14014A)	14014-0038	1
PIPE-OIL (Ref # 39193)	39193-0577	1
WASHER-SEAL,10.1X14.5X1.5 (Ref # 49091)	49091-0001	4
FITTING (Ref # 92005)	92005-0043	1
PIN,10X14 (Ref # 92043)	92043-1506	3
PIN,6X16 (Ref # 92043A)	92043-1690	1
BEARING-NEEDLE,HK1412FM (Ref # 92046)	92046-0043	1
SEAL-OIL,TC38 57 8 (Ref # 92049)	92049-0068	1
SEAL-OIL,TC14245 (Ref # 92049A)	92049-1520	1
RING-O,13.8X1.9 (Ref # 92055)	92055-0065	1
NOZZLE (Ref # 92062)	92062-0027	3
NOZZLE (Ref # 92062A)	92062-0028	1
PLUG (Ref # 92066)	92066-0066	1
PLUG (Ref # 92066A)	92066-0836	2
BOLT,BANJO,10X23 (Ref # 92150)	92150-1641	4
BOLT,TORX,8X16 (Ref # 92154)	92154-1787	3
BOLT,TORX,6X11.7 (Ref # 92154A)	92154-1821	2
CLAMP (Ref # 92171)	92171-0533	1
CLAMP (Ref # 92171A)	92171-0689	1
TUBE,11X17X180 (Ref # 92192)	92192-1407	1
O RING,16MM (Ref # 670)	670D2016	2