

1997 Ninja® ZX™ -6R PARTS DIAGRAM

Battery Case

F2132

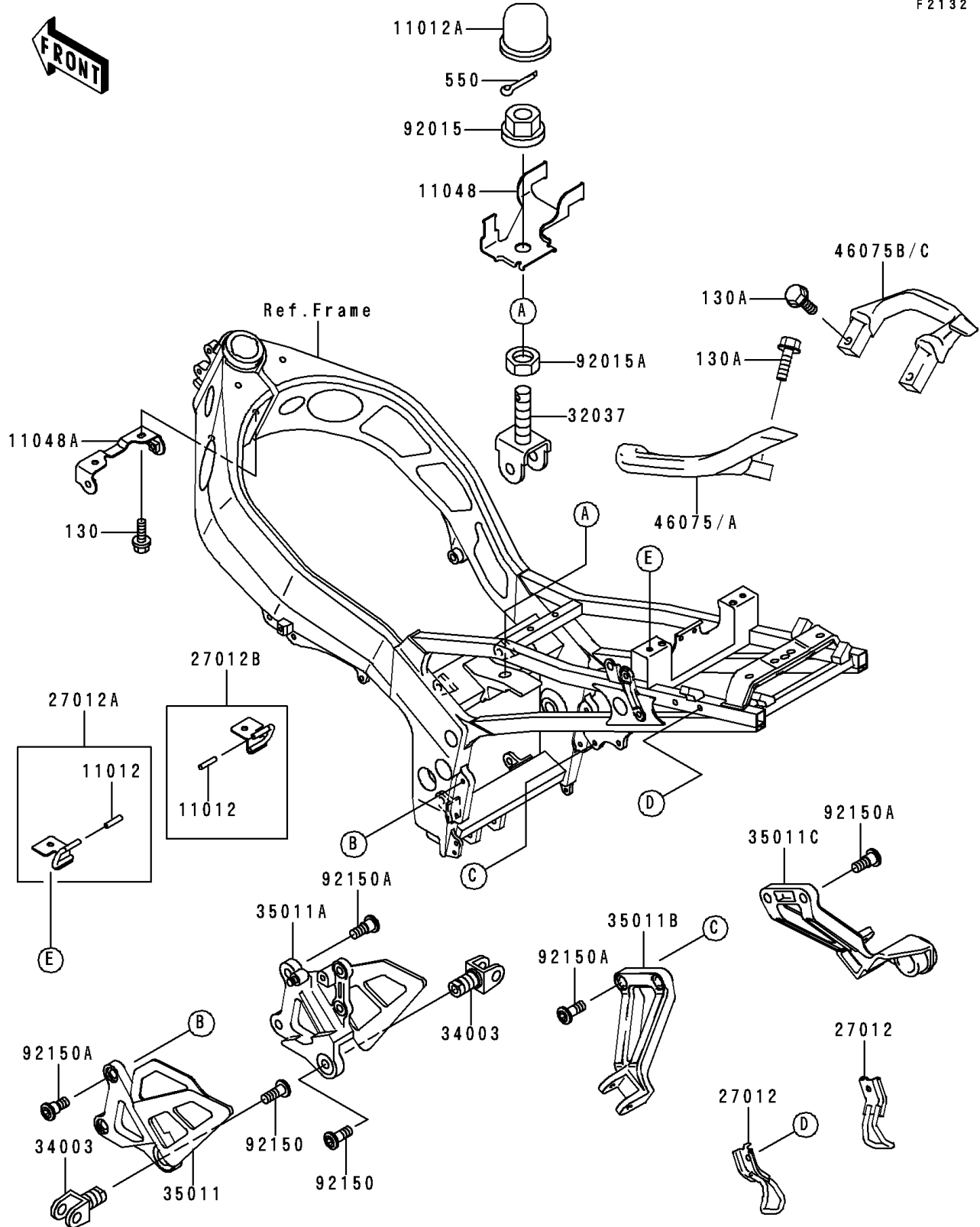

1997 Ninja® ZX™ -6R PARTS LIST

Battery Case

ITEM NAME	PART NUMBER	QUANTITY
BOLT-FLANGED,6X14,BLACK (Ref # 130)	130J0614	2
BOLT-FLANGED,8X30 (Ref # 130A)	130J0830	4
PIN-COTTER,4.0X25 (Ref # 550)	550D4025	1
CAP,BUNGEE CORD HOOK (Ref # 11012)	11012-1589	2
CAP (Ref # 11012A)	11012-1844	1
BRACKET,FUEL PUMP (Ref # 11048)	11048-1859	1
BRACKET,RADIATOR (Ref # 11048A)	11048-1860	1
HOOK,BUNGEE CORD,RR (Ref # 27012)	27012-1475	2
HOOK,HELMET,LH (Ref # 27012A)	27012-1505	1
HOOK,HELMET,RH (Ref # 27012B)	27012-1506	1
BRACKET-SHOCKABSORBER (Ref # 32037)	32037-1657	1
HOLDER-STEP (Ref # 34003)	34003-1327	2
STAY,FR,LH (Ref # 35011)	35011-1552	1
STAY,FR,RH (Ref # 35011A)	35011-1553	1
STAY,REAR STEP,LH (Ref # 35011B)	35011-1736	1
STAY,REAR STEP,RH (Ref # 35011C)	35011-1737	1
GRIP,RR,LH,F.BLACK (Ref # 46075A)	46075-1115-21	1
GRIP,RR,RH,F.BLACK (Ref # 46075C)	46075-1116-21	1
NUT,FLANGED,16MM (Ref # 92015)	92015-1881	1
NUT,16MM (Ref # 92015A)	92015-1953	1
BOLT,SOCKET,10X25 (Ref # 92150)	92150-1268	2
BOLT,SOCKET,8X20 (Ref # 92150A)	92150-1839	8