

# 2024 NINJA® ZX™ -6R ABS PARTS DIAGRAM

Fuel Injection

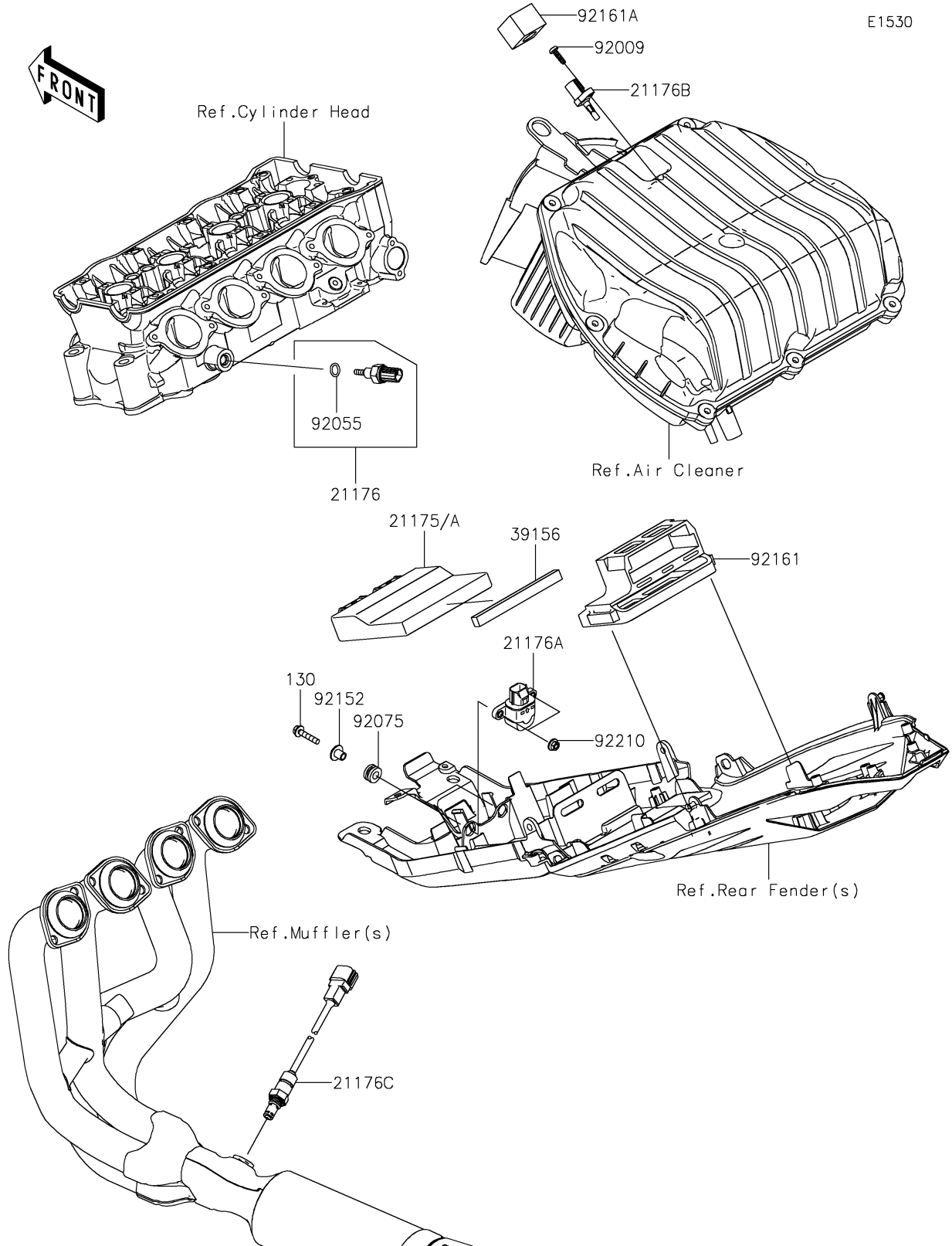

## 2024 NINJA® ZX™ -6R ABS PARTS LIST

### Fuel Injection

ITEM NAME	PART NUMBER	QUANTITY
CONTROL UNIT-ELECTRONIC (Ref # 21175)	21175-1916	1
CONTROL UNIT-ELECTRONIC (Ref # 21175A)	21175-1917	1
SENSOR,WATER TEMP (Ref # 21176)	21176-0009	1
SENSOR,VEHICLE-DOWN (Ref # 21176A)	21176-0026	1
SENSOR,AIR TEMPERATURE (Ref # 21176B)	21176-0048	1
SENSOR,OXYGEN (Ref # 21176C)	21176-0933	1
PAD (Ref # 39156)	39156-2846	1
SCREW,TAPPING,5X16 (Ref # 92009)	92009-1984	1
RING-O,9.5X1.9 (Ref # 92055)	92055-0016	1
DAMPER (Ref # 92075)	92075-1912	2
COLLAR (Ref # 92152)	92152-0134	2
DAMPER (Ref # 92161)	92161-0356	1
DAMPER (Ref # 92161A)	92161-1525	1
NUT,FLANGED,5MM (Ref # 92210)	92210-0007	2
BOLT-FLANGED,5X25 (Ref # 130)	130BA0525	2