

2024 KLR® 650 PARTS DIAGRAM

Fuel Evaporative System(CA)

E1650

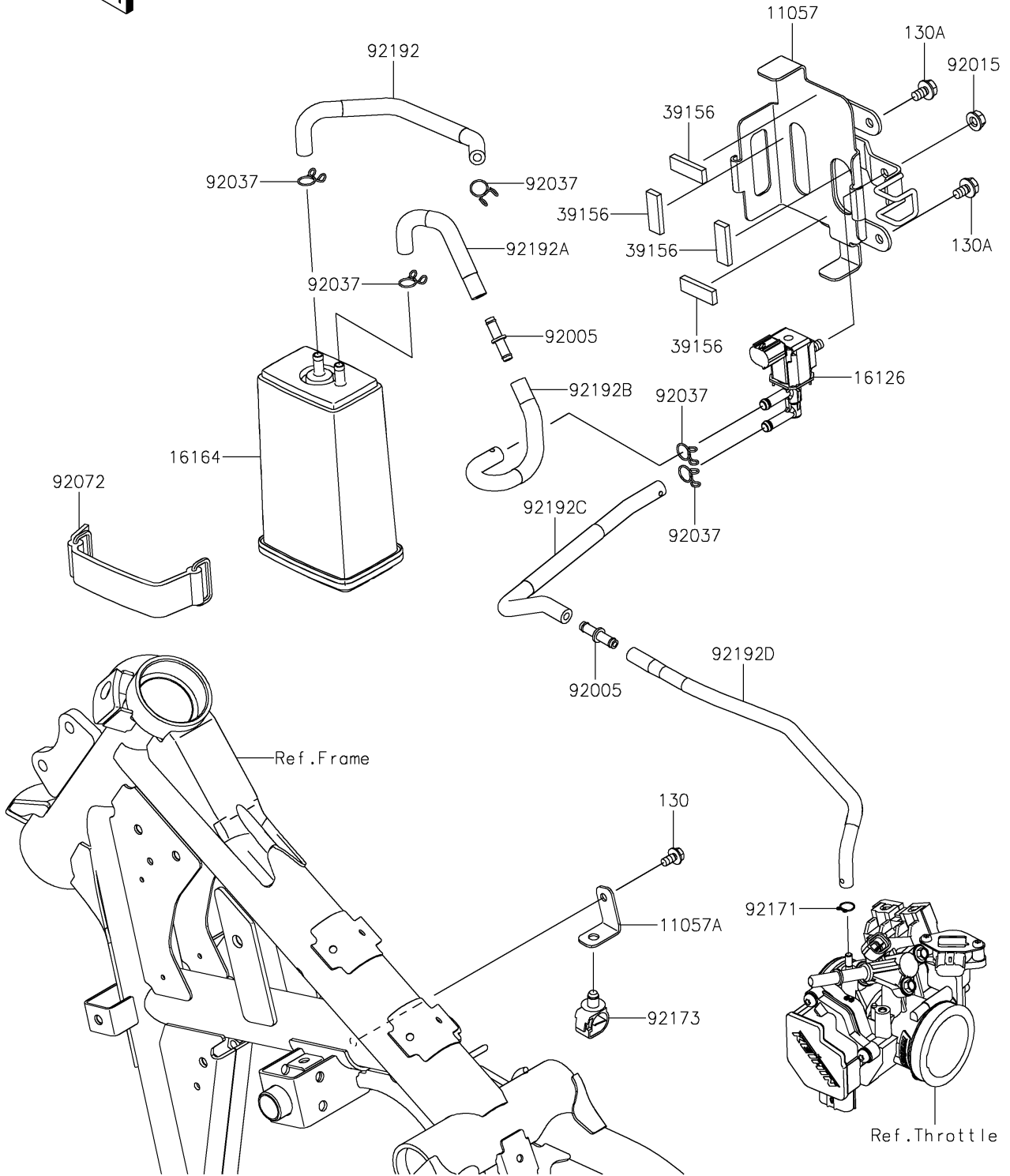

2024 KLR® 650 PARTS LIST

Fuel Evaporative System(CA)

ITEM NAME	PART NUMBER	QUANTITY
BRACKET,CANISTER (Ref # 11057)	11057-4309	1
BRACKET,EVAPO TUBE (Ref # 11057A)	11057-4394	1
VALVE,SOLENOID (Ref # 16126)	16126-0705	1
CANISTER (Ref # 16164)	16164-0012	1
PAD,10X30X4 (Ref # 39156)	39156-0927	4
FITTING (Ref # 92005)	92005-0721	2
NUT,FLANGED,6MM (Ref # 92015)	92015-1367	1
CLAMP,TUBE (Ref # 92037)	92037-147	5
BAND,L=90 (Ref # 92072)	92072-0135	1
CLAMP (Ref # 92171)	92171-0573	1
CLAMP,12MM DIA. (Ref # 92173)	92173-0736	1
TUBE,TANK-CANISTER (Ref # 92192)	92192-2455	1
TUBE,CANISTER-FITTING (Ref # 92192A)	92192-2456	1
TUBE,FITTING-VALVE (Ref # 92192B)	92192-2457	1
TUBE,VALVE-FITTING (Ref # 92192C)	92192-2458	1
TUBE,FITTING-THROTTLEBODY (Ref # 92192D)	92192-2591	1
BOLT-FLANGED,5X10 (Ref # 130)	130BA0510	1
BOLT-FLANGED,6X10 (Ref # 130A)	130BA0610	2