

2023 KLR® 650 PARTS DIAGRAM

Cylinder Head

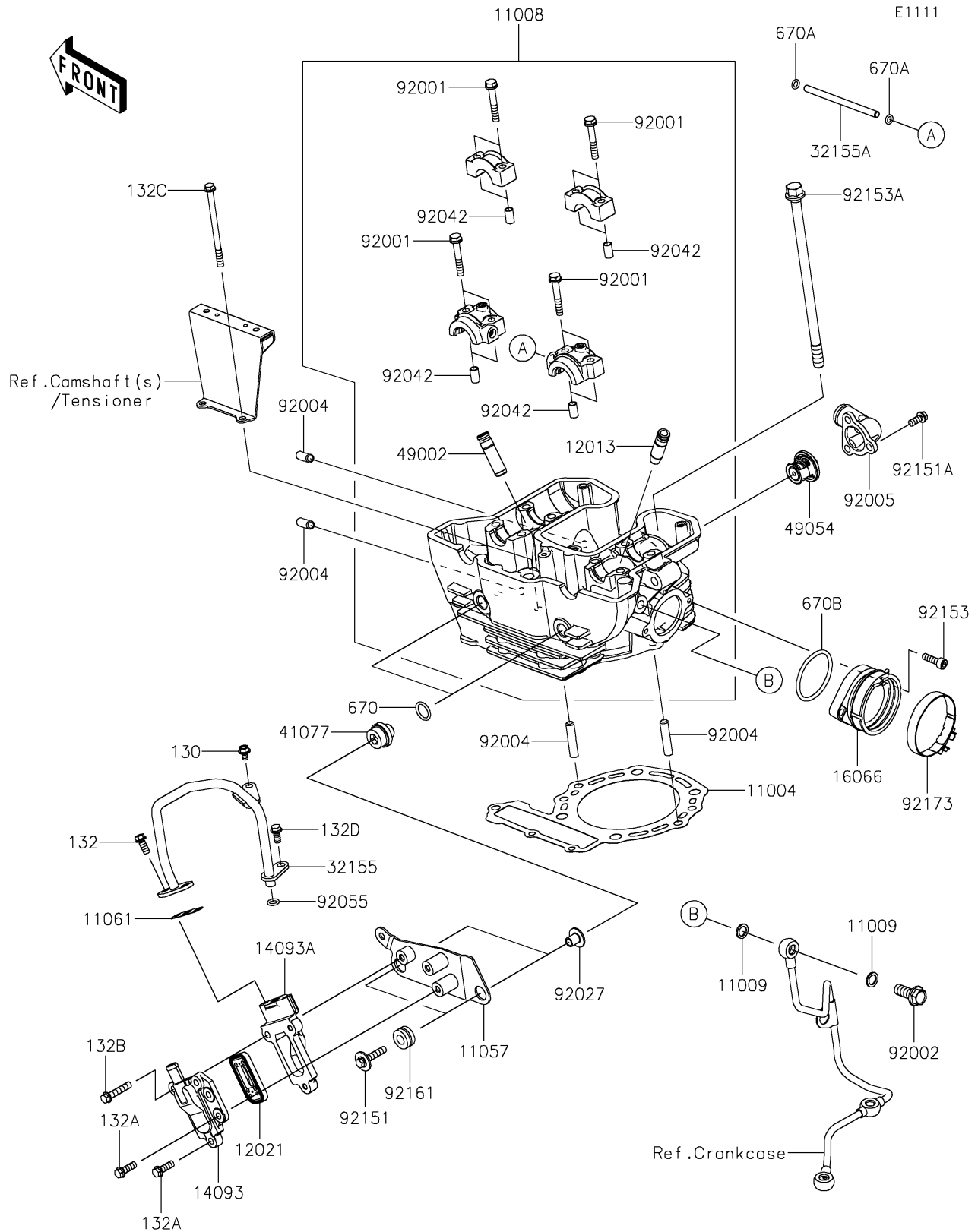

2023 KLR® 650 PARTS LIST

Cylinder Head

ITEM NAME	PART NUMBER	QUANTITY
GASKET-HEAD (Ref # 11004)	11004-1158	1
HEAD-COMP-CYLINDER (Ref # 11008)	11008-1451	1
GASKET,10X14.5X1.5 (Ref # 11009)	11009-1105	2
BRACKET,REED VALVE COVER (Ref # 11057)	11057-7187	1
GASKET,REED VALVE COVER (Ref # 11061)	11061-1396	1
GUIDE-VALVE,INTAKE (Ref # 12013)	12013-009	2
VALVE-ASSY-REED (Ref # 12021)	12021-0017	1
COVER,REED VALVE,FR (Ref # 14093)	14093-1081	1
COVER,REED VALVE,RR (Ref # 14093A)	14093-1123	1
HOLDER-THROTTLE BODY (Ref # 16066)	16066-0023	1
PIPE,2ND AIR (Ref # 32155)	32155-4382	1
PIPE,OIL LINE (Ref # 32155A)	32155-4449	1
ADAPTER (Ref # 41077)	41077-0751	2
GUIDE-VALVE,EXHAUST (Ref # 49002)	49002-1002	2
THERMOSTAT (Ref # 49054)	49054-1053	1
BOLT,FLANGED,6X38 (Ref # 92001)	92001-1105	8
BOLT,BANJO,10X25 (Ref # 92002)	92002-1170	1
STUD,8X22 (Ref # 92004)	92004-1217	4
FITTING (Ref # 92005)	92005-0715	1
COLLAR,FLANGED,L=12.1,BLACK (Ref # 92027)	92027-1651	2
PIN,DOWEL,6.3X8X14 (Ref # 92042)	92042-007	8
RING-O,10MM (Ref # 92055)	92055-1149	1
BOLT,FLANGED,6X30 (Ref # 92151)	92151-1105	2
BOLT,6X14 (Ref # 92151A)	92151-1810	3
BOLT,SOCKET,6X20 (Ref # 92153)	92153-1364	2
BOLT,FLANGED,10X191 (Ref # 92153A)	92153-1797	4
DAMPER (Ref # 92161)	92161-2424	2
CLAMP,62MM (Ref # 92173)	92173-0922	1
BOLT-FLANGED,5X8 (Ref # 130)	130BD0508	1

2023 KLR® 650 PARTS LIST

Cylinder Head

ITEM NAME	PART NUMBER	QUANTITY
BOLT-FLANGED-SMALL,6X14 (Ref # 132)	132BA0614	2
BOLT-FLANGED-SMALL,6X18 (Ref # 132A)	132BA0618	4
BOLT-FLANGED-SMALL,6X30 (Ref # 132B)	132BA0630	1
BOLT-FLANGED-SMALL,6X85 (Ref # 132C)	132BA0685	2
BOLT-FLANGED-SMALL,6X12 (Ref # 132D)	132BD0612	1
O RING,15MM (Ref # 670)	670B2015	2
O RING,6MM (Ref # 670A)	670D1506	2
O RING,48MM (Ref # 670B)	670D3048	1