

2021 TERYX KRX® 1000 SPECIAL EDITION PARTS DIAGRAM

Other(Winch)

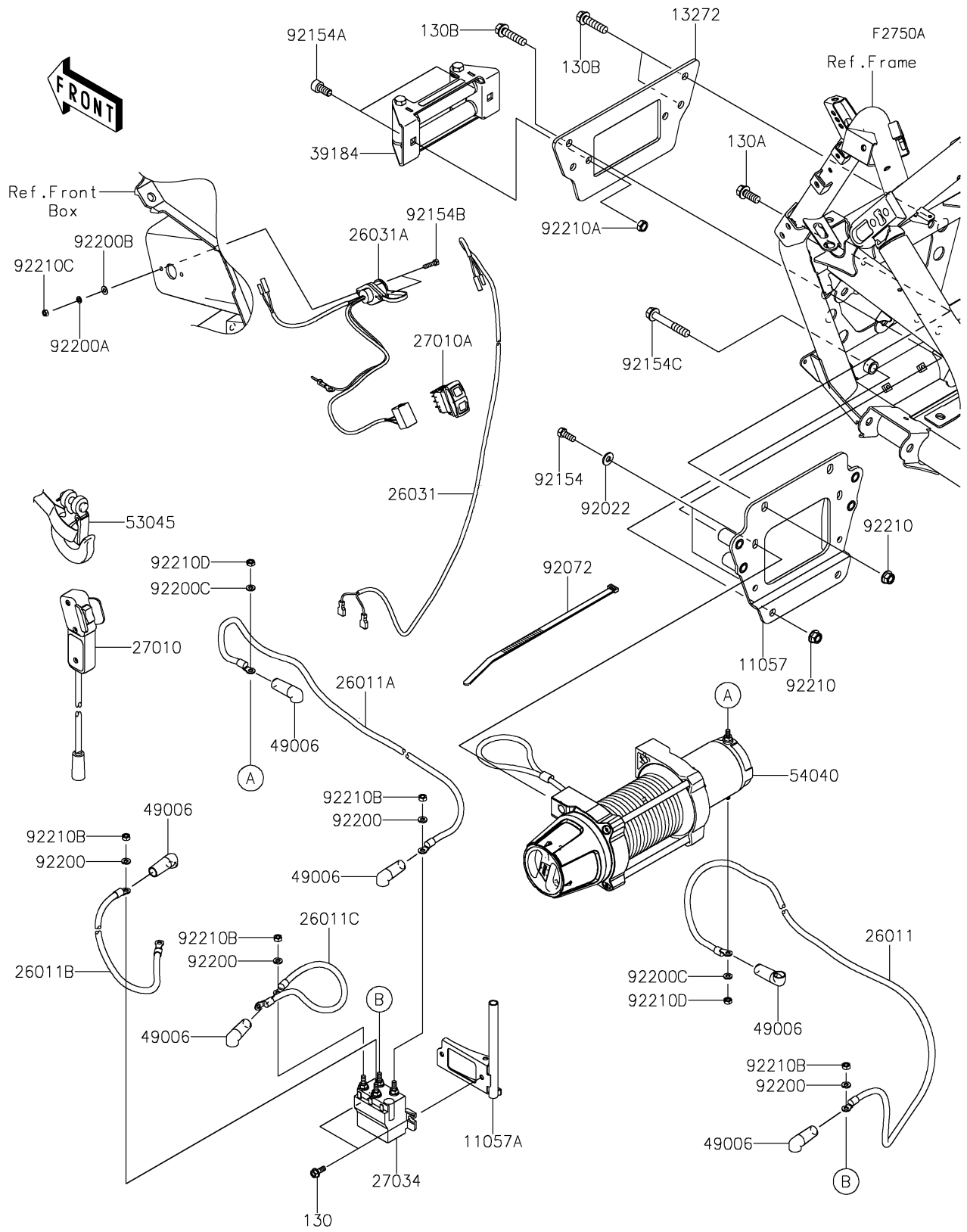

2021 TERYX KRX® 1000 SPECIAL EDITION PARTS LIST

Other(Winch)

ITEM NAME	PART NUMBER	QUANTITY
BRACKET,WINCH (Ref # 11057)	11057-3707	1
BRACKET,WINCH RELAY (Ref # 11057A)	11057-3729	1
PLATE,FAIRLEAD (Ref # 13272)	13272-2847	1
WIRE-LEAD,BLUE (Ref # 26011)	26011-1922	1
WIRE-LEAD,YELLOW (Ref # 26011A)	26011-1923	1
WIRE-LEAD,RED (Ref # 26011B)	26011-1924	1
WIRE-LEAD,BLACK (Ref # 26011C)	26011-1925	1
HARNESS,REMOTE (Ref # 26031)	26031-2842	1
HARNESS,CONTACTOR (Ref # 26031A)	26031-2843	1
SWITCH,REMOTE (Ref # 27010)	27010-0820	1
SWITCH,ON/OFF (Ref # 27010A)	27010-0942	1
RELAY (Ref # 27034)	27034-0008	1
BRACKET-ASSY (Ref # 39184)	39184-0742	1
BOOT (Ref # 49006)	49006-0601	6
HOOK-ASSY (Ref # 53045)	53045-0028	1
WINCH (Ref # 54040)	54040-0008	1
WASHER,8.2X19X2 (Ref # 92022)	92022-1533	4
BAND,L=292.1 (Ref # 92072)	92072-3509	10
BOLT,8X20 (Ref # 92154)	92154-1876	4
BOLT,SOCKET,10X20 (Ref # 92154A)	92154-1877	2
BOLT,5X20 (Ref # 92154B)	92154-1879	2
BOLT,FLANGED,10X65 (Ref # 92154C)	92154-4265	2
WASHER,6 LOCK (Ref # 92200)	92200-1776	4
WASHER,5 LOCK (Ref # 92200A)	92200-1777	2
WASHER (Ref # 92200B)	92200-1778	2
WASHER,6.4X12X1.8 (Ref # 92200C)	92200-2358	2
NUT,LOCK,FLANGED,10MM (Ref # 92210)	92210-1080	4
NUT,LOCK,M10 (Ref # 92210A)	92210-1432	2
NUT,M6X1.00 (Ref # 92210B)	92210-1434	4

2021 TERYX KRX® 1000 SPECIAL EDITION PARTS LIST

Other(Winch)

ITEM NAME	PART NUMBER	QUANTITY
NUT,M5X0.80 (Ref # 92210C)	92210-1435	2
NUT,6MM (Ref # 92210D)	92210-1792	2
BOLT-FLANGED,6X16 (Ref # 130)	130BA0616	2
BOLT-FLANGED (Ref # 130A)	130CA1025	2
BOLT-FLANGED,10X40 (Ref # 130B)	130CA1040	4