

1996 Ninja® 600R PARTS DIAGRAM

Gear Change Mechanism

E1370-0153

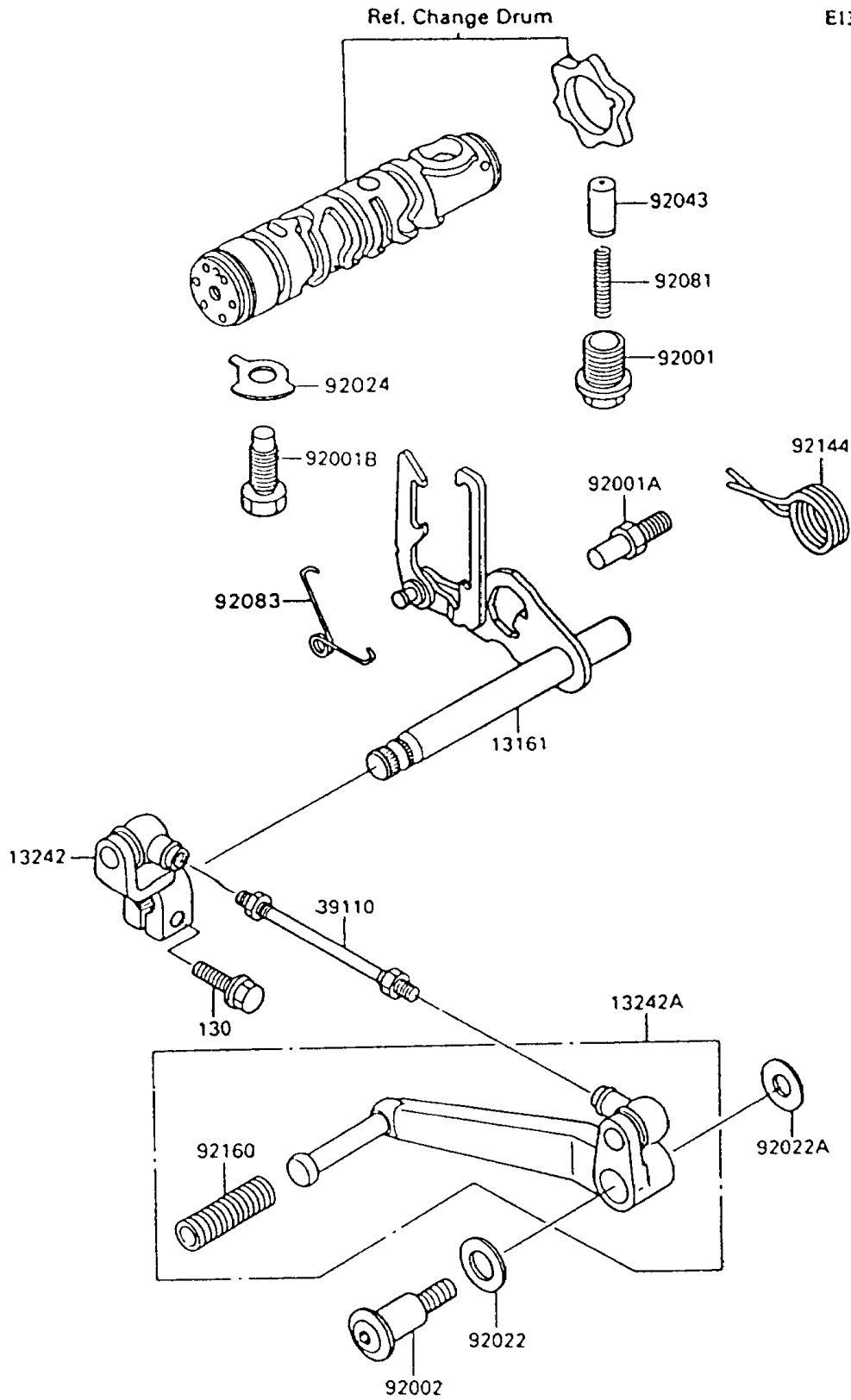

1996 Ninja® 600R PARTS LIST

Gear Change Mechanism

ITEM NAME	PART NUMBER	QUANTITY
LEVER-COMP-CHANGE SHAFT (Ref # 13161)	13161-042	1
LEVER-ASSY-CHANGE,BOSS (Ref # 13242)	13242-1190	1
LEVER-ASSY-CHANGE,PEDAL (Ref # 13242A)	13242-1191	1
ROD-ASSY-TIE,CHANGE LEVER (Ref # 39110)	39110-1010	1
BOLT,NEUTRAL POSITION (Ref # 92001)	92001-1037	1
BOLT,RETURN SPRING (Ref # 92001A)	92001-1455	1
BOLT,10X26 (Ref # 92001B)	92001-174	1
BOLT,CHANGE PEDAL (Ref # 92002)	92002-1926	1
WASHER,12.5X21X1.2 (Ref # 92022)	92022-072	1
WASHER,8.5X20X1.6 (Ref # 92022A)	92022-1561	1
WASHER,LOCK,10MM (Ref # 92024)	92024-074	1
PIN (Ref # 92043)	92043-076	1
SPRING (Ref # 92081)	92081-112	1
SPRING (Ref # 92083)	92083-018	1
SPRING,CHANGE PEDAL RETURN (Ref # 92144)	92144-1074	1
DAMPER,CHANGE PEDAL (Ref # 92160)	92160-1036	1
BOLT-FLANGED,6X20,BLACK (Ref # 130)	130S0620	1