

1994 Ninja® 600R PARTS DIAGRAM

Oil Pump/Oil Filter

E1710-0039

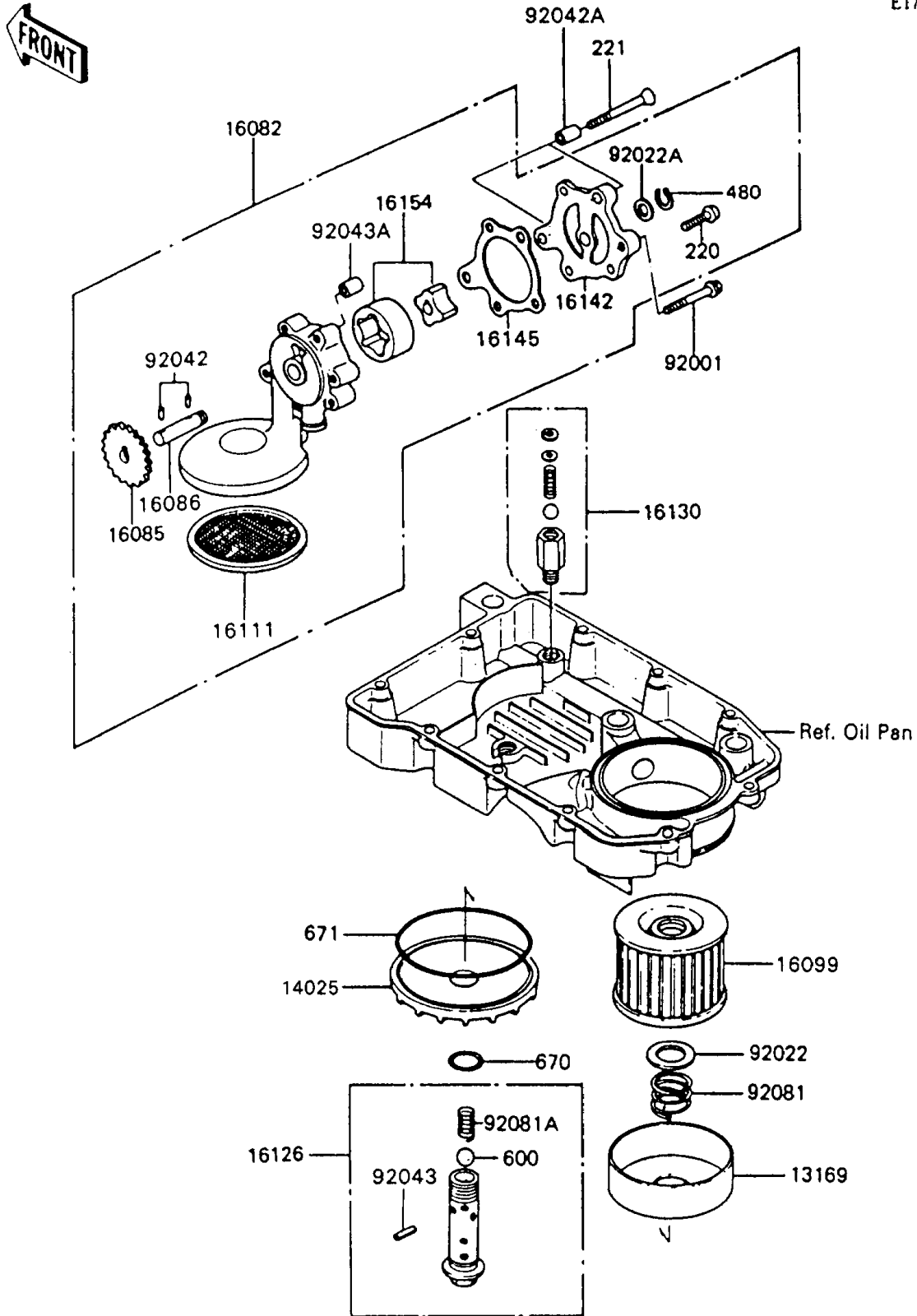

1994 Ninja® 600R PARTS LIST

Oil Pump/Oil Filter

ITEM NAME	PART NUMBER	QUANTITY
PLATE,OIL FILTER (Ref # 13169)	13169-1110	1
COVER,OIL FILTER,F.BLACK (Ref # 14025)	14025-1422	1
PUMP-ASSY-OIL (Ref # 16082)	16082-064	1
GEAR,OIL PUMP,57T (Ref # 16085)	16085-025	1
SHAFT,OIL PUMP (Ref # 16086)	16086-004	1
ELEMENT-OIL FILTER (Ref # 16099)	16099-003	1
FILTER,OIL PUMP (Ref # 16111)	16111-004	1
VALVE,OIL FILTER (Ref # 16126)	16126-1108	1
VALVE-ASSY-RELIEF (Ref # 16130)	16130-1001	1
COVER-PUMP (Ref # 16142)	16142-005	1
GASKET,OIL PUMP COVER (Ref # 16145)	16145-004	1
ROTOR-PUMP (Ref # 16154)	16154-003	1
BOLT,FLANGED,6X45 (Ref # 92001)	92001-165	1
WASHER,20.5X30X1 (Ref # 92022)	92022-1012	1
WASHER,11.2X15X1 (Ref # 92022A)	92022-311	1
PIN,DOWEL,4X12.8 (Ref # 92042)	92042-041	2
PIN,DOWEL,8X28 (Ref # 92042A)	92042-050	2
PIN,SPRING,2X20 (Ref # 92043)	92043-111	1
PIN,DOWEL,8X10 (Ref # 92043A)	92043-1302	1
SPRING,OIL FILTER (Ref # 92081)	92081-1018	1
SPRING (Ref # 92081A)	92081-109	1
SCREW-PAN-CROS,6X18 (Ref # 220)	220B0618	3
SCREW-CSK-CROS,6X55 (Ref # 221)	221B0655	2
CIRCLIP-TYPE-C,11MM (Ref # 480)	480J1100	1
BALL-STEEL,3/8" (Ref # 600)	600A1200	1
O RING,16MM (Ref # 670)	670B2016	1
O RING,90MM (Ref # 671)	671B2590	1