

2024 Vulcan S PARTS DIAGRAM

Stand(s)

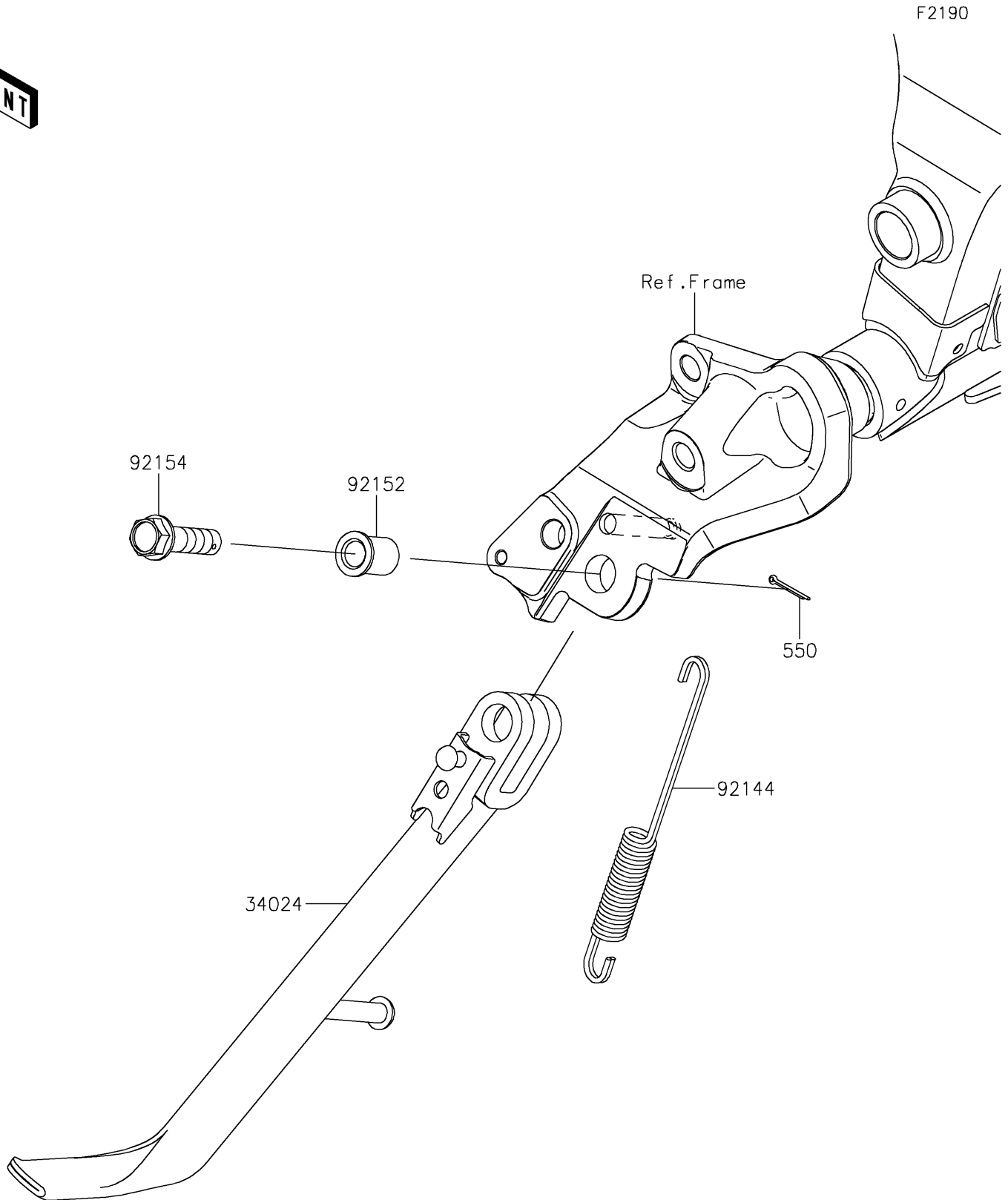

2024 Vulcan S PARTS LIST

Stand(s)

| ITEM NAME | PART NUMBER | QUANTITY |
|-----------------------------------|-------------|----------|
| STAND-SIDE (Ref # 34024) | 34024-0127 | 1 |
| SPRING,SIDE STAND (Ref # 92144) | 92144-1818 | 1 |
| COLLAR,10.2X15X20.1 (Ref # 92152) | 92152-1914 | 1 |
| BOLT,FLANGED,10X37 (Ref # 92154) | 92154-1539 | 1 |
| PIN-COTTER,2.0X15 (Ref # 550) | 550AA2015 | 1 |