

2024 MULE™ 4010 4x4 PARTS DIAGRAM

Fuel Injection

E1530

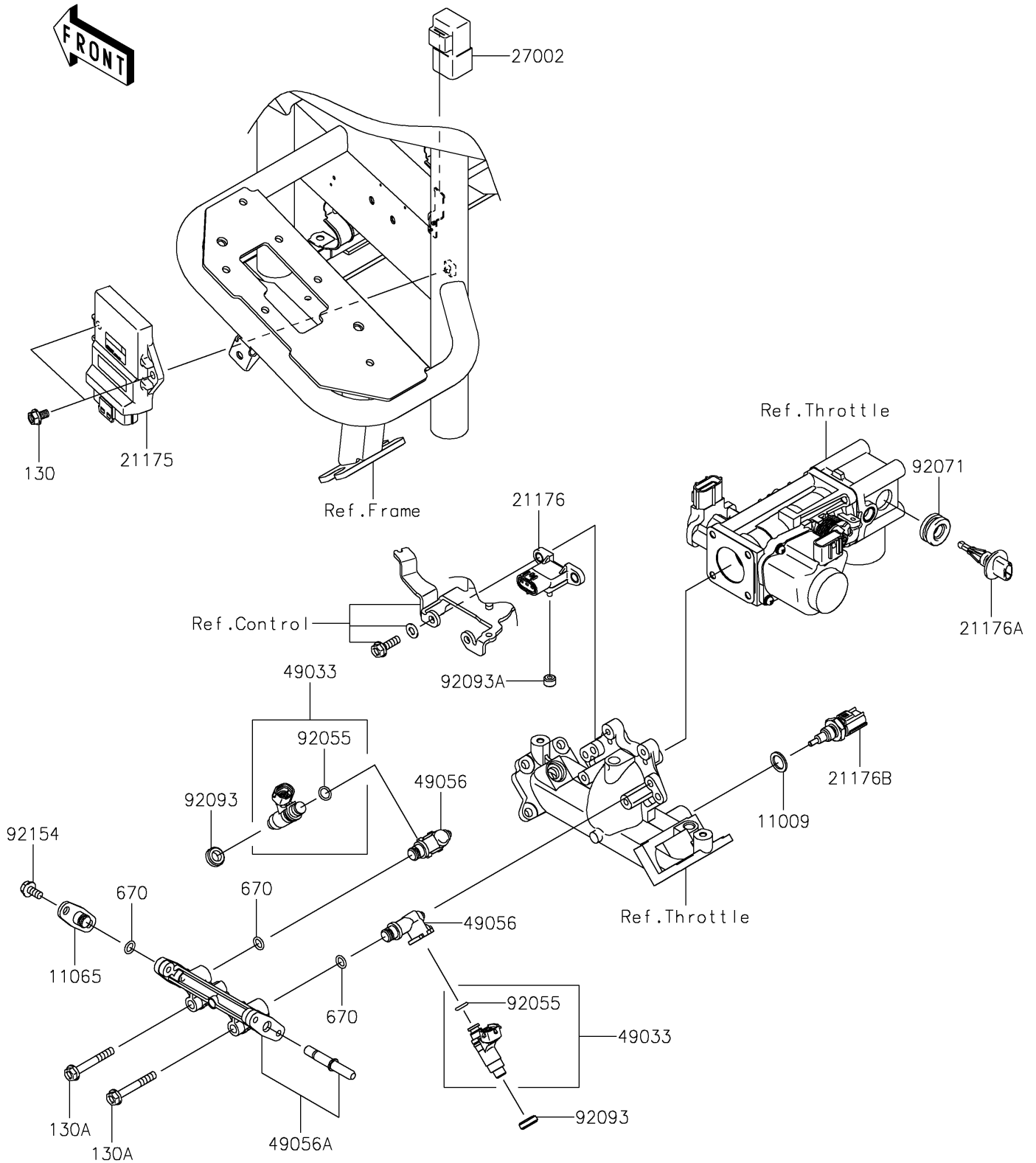

2024 MULE™ 4010 4x4 PARTS LIST

Fuel Injection

ITEM NAME	PART NUMBER	QUANTITY
GASKET,12.5X18X1.5 (Ref # 11009)	11009-1376	1
CAP (Ref # 11065)	11065-2129	1
CONTROL UNIT-ELECTRONIC,F.I. (Ref # 21175)	21175-1781	1
SENSOR,PRESSURE (Ref # 21176)	21176-1095	1
SENSOR,AIR TEMP (Ref # 21176A)	21176-2106	1
SENSOR (Ref # 21176B)	21176-2111	1
RELAY-ASSY (Ref # 27002)	27002-1088	1
NOZZLE-INJECTION (Ref # 49033)	49033-2060	2
PIPE-INJECTION (Ref # 49056)	49056-2062	2
PIPE-INJECTION (Ref # 49056A)	49056-6003	1
RING-O,INJECTION NOZZLE (Ref # 92055)	92055-1622	2
GROMMET (Ref # 92071)	92071-0781	1
SEAL (Ref # 92093)	92093-0718	2
SEAL (Ref # 92093A)	92093-2127	1
BOLT,6X12 (Ref # 92154)	92154-2938	2
BOLT-FLANGED,6X16 (Ref # 130)	130BB0616	2
BOLT-FLANGED,6X45 (Ref # 130A)	130CA0645	2
O RING,8MM (Ref # 670)	670E1508	3