

2024 KLX150L (Indonesia Only) PARTS DIAGRAM

Crankcase

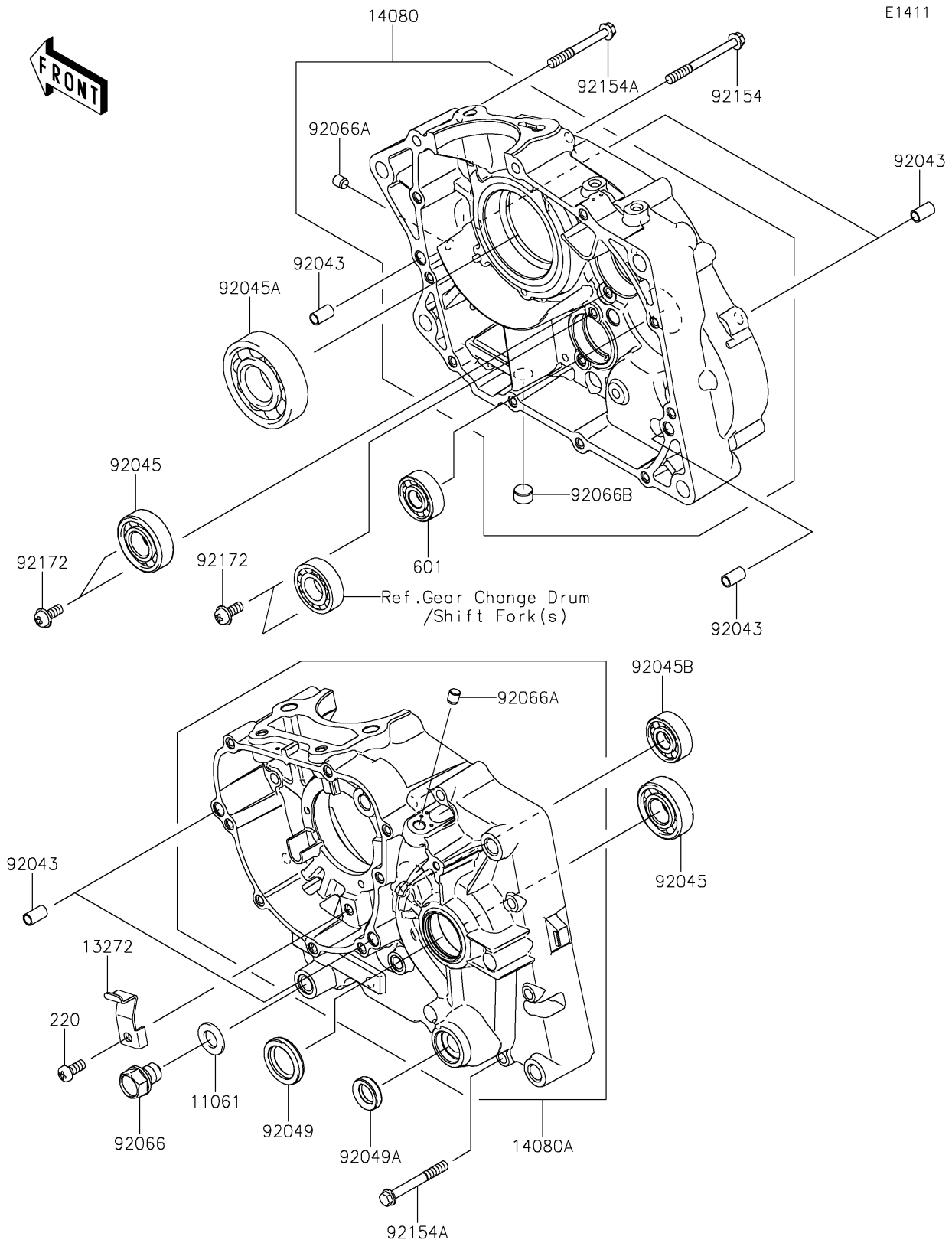

2024 KLX150L (Indonesia Only) PARTS LIST

Crankcase

ITEM NAME	PART NUMBER	QUANTITY
GASKET,DRAIN PLUG (Ref # 11061)	11061-0421	1
PLATE (Ref # 13272)	13272-1384	1
CRANKCASE,RH (Ref # 14080)	14080-0251	1
CRANKCASE,LH (Ref # 14080A)	14080-0928	1
PIN,6.2X8X14 (Ref # 92043)	92043-1741	6
BEARING-BALL,#6203C2 (Ref # 92045)	92045-0745	2
BEARING-BALL,25X62X17 (Ref # 92045A)	92045-0895	1
BEARING-BALL,12X32X10 (Ref # 92045B)	92045-0896	1
SEAL-OIL (Ref # 92049)	92049-0811	1
SEAL-OIL (Ref # 92049A)	92049-1431	1
PLUG,OIL DRAIN,12X15 (Ref # 92066)	92066-0768	1
PLUG,OIL LINE,7.2X8 (Ref # 92066A)	92066-1012	2
PLUG (Ref # 92066B)	92066-1110	1
BOLT,6X60 (Ref # 92154)	92154-1161	1
BOLT,6X50 (Ref # 92154A)	92154-1168	10
SCREW,6X14 (Ref # 92172)	92172-0850	4
SCREW-PAN-CROS,6X14 (Ref # 220)	220AA0614	1
BEARING-BALL (Ref # 601)	601A6201	1