

2000 Ninja® ZX™-12R PARTS DIAGRAM

Swingarm

F2141

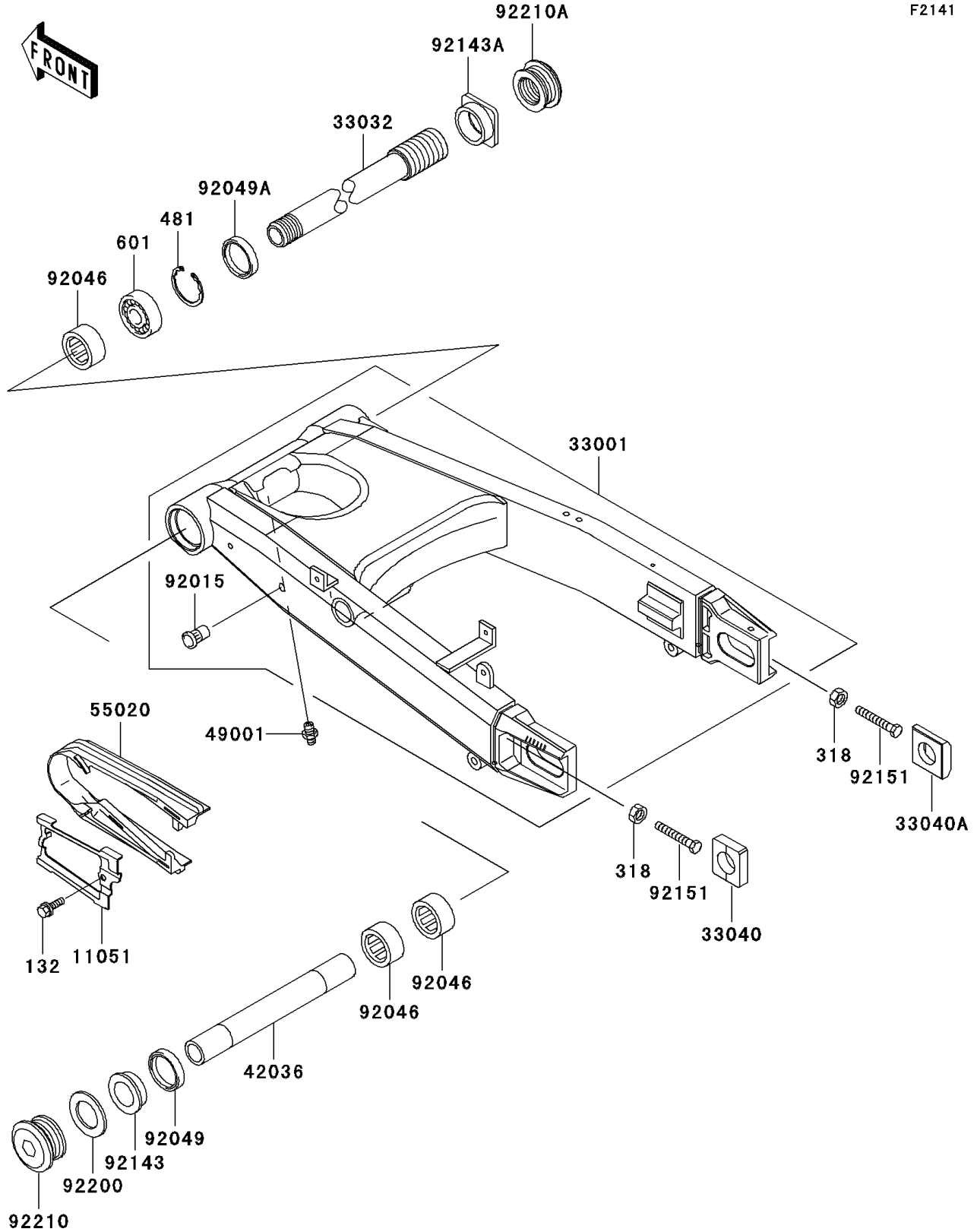

2000 Ninja® ZX™-12R PARTS LIST

Swingarm

ITEM NAME	PART NUMBER	QUANTITY
BOLT-FLANGED-SMALL (Ref # 132)	132J0612	1
NUT-HEX-SMALL,8MM (Ref # 318)	318G0800	2
CIRCLIP-TYPE-C,47MM (Ref # 481)	481J4700	1
BEARING-BALL,#6005U (Ref # 601)	601B6005U	1
BRACKET,CHAIN GUARD (Ref # 11051)	11051-1912	1
ARM-COMP-SWING,SILVER (Ref # 33001)	33001-1572-TX	1
SHAFT-SWING ARM (Ref # 33032)	33032-1193	1
ADJUSTER-CHAIN (Ref # 33040)	33040-1114	1
ADJUSTER-CHAIN,RH (Ref # 33040A)	33040-1180	1
SLEEVE,SWING ARM,L=224.5 (Ref # 42036)	42036-1312	1
NIPPLE-GREASE (Ref # 49001)	49001-1051	1
GUARD,CHAIN (Ref # 55020)	55020-1695	1
NUT,POP,6MM,L=16.5 (Ref # 92015)	92015-1792	1
BEARING-NEEDLE,BM3520 (Ref # 92046)	92046-1205	3
SEAL-OIL,MHA 35 47 5 (Ref # 92049)	92049-1381	1
SEAL-OIL,KC38X47X6 (Ref # 92049A)	92049-1521	1
COLLAR,SWING ARM,L=12.5 (Ref # 92143)	92143-1481	1
COLLAR,SWING ARM,L=15.5 (Ref # 92143A)	92143-1681	1
BOLT,8X55 (Ref # 92151)	92151-1578	2
WASHER,25.5X42X2.3 (Ref # 92200)	92200-1084	1
NUT,M25X1.5 (Ref # 92210)	92210-1191	1
NUT,M32X1.5 (Ref # 92210A)	92210-1192	1