

2025 Vulcan 900 Classic PARTS DIAGRAM

Water Pipe

E3037

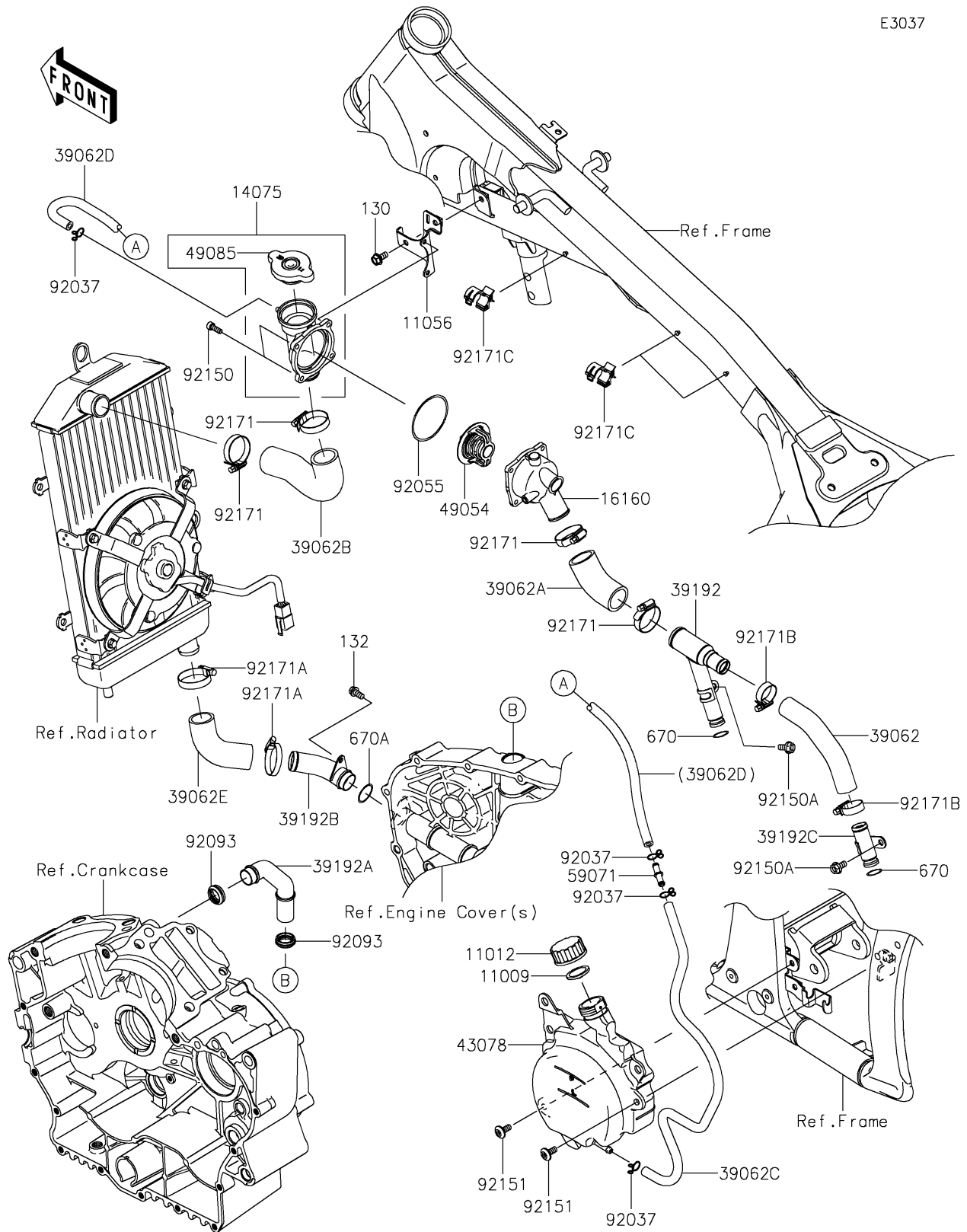

2025 Vulcan 900 Classic PARTS LIST

Water Pipe

ITEM NAME	PART NUMBER	QUANTITY
GASKET,RESERVOIR TANK CAP (Ref # 11009)	11009-1145	1
CAP (Ref # 11012)	11012-1084	1
BRACKET (Ref # 11056)	11056-1356	1
CAP-ASSY (Ref # 14075)	14075-0001	1
BODY (Ref # 16160)	16160-0781	1
HOSE-COOLING,RR HEAD-PIPE (Ref # 39062)	39062-0118	1
HOSE-COOLING,PIPE-THERMO (Ref # 39062A)	39062-0120	1
HOSE-COOLING,THERMO-RAD (Ref # 39062B)	39062-0121	1
HOSE-COOLING,RESERVOIR-JOINT (Ref # 39062C)	39062-0124	1
HOSE-COOLING,JOINT-THERMO (Ref # 39062D)	39062-0132	1
HOSE-COOLING,PIPE-WATER PUMP (Ref # 39062E)	39062-0717	1
PIPE-WATER,FR HEAD (Ref # 39192)	39192-0042	1
PIPE-WATER (Ref # 39192A)	39192-0043	1
PIPE-WATER (Ref # 39192B)	39192-0044	1
PIPE-WATER,RR HEAD (Ref # 39192C)	39192-0048	1
RESERVOIR (Ref # 43078)	43078-0045	1
THERMOSTAT (Ref # 49054)	49054-0004	1
CAP-ASSY-PRESSURE (Ref # 49085)	49085-1066	1
JOINT (Ref # 59071)	59071-3717	1
CLAMP,TUBE (Ref # 92037)	92037-147	4
RING-O,53.5X2.6 (Ref # 92055)	92055-0831	1
SEAL (Ref # 92093)	92093-1427	2
BOLT,SOCKET,5X14 (Ref # 92150)	92150-1180	4
BOLT,FLANGED,6X12 (Ref # 92150A)	92150-1826	2
BOLT,SOCKET,6X14 (Ref # 92151)	92151-1654	2
CLAMP (Ref # 92171)	92171-0179	4
CLAMP (Ref # 92171A)	92171-0261	2
CLAMP (Ref # 92171B)	92171-0338	2
CLAMP,15MM DIA. (Ref # 92171C)	92171-1424	3

2025 Vulcan 900 Classic PARTS LIST

Water Pipe

ITEM NAME	PART NUMBER	QUANTITY
BOLT-FLANGED,6X14 (Ref # 130)	130BA0614	1
BOLT-FLANGED-SMALL,6X12 (Ref # 132)	132BA0612	1
O RING,14MM (Ref # 670)	670B2014	2
O RING,21MM (Ref # 670A)	670B2021	1