

2025 NINJA® ZX™ -10R PARTS DIAGRAM

Accessory(Marchesini Wheel)

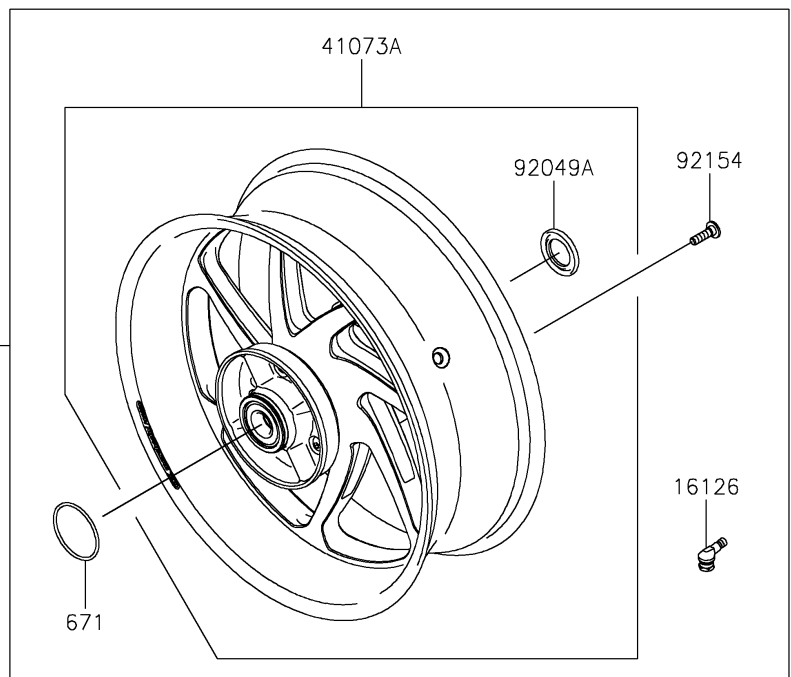
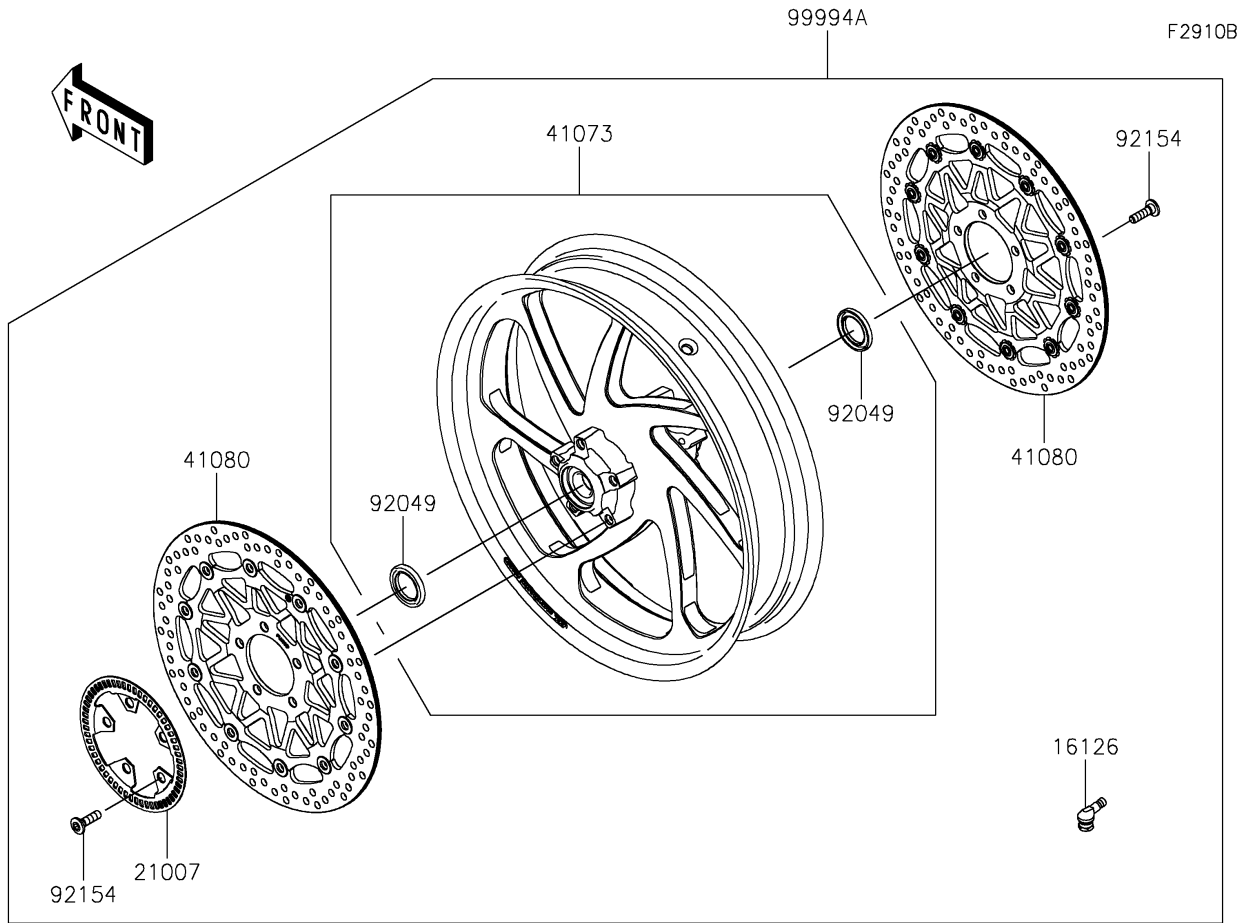

2025 NINJA® ZX™ -10R PARTS LIST

Accessory(Marchesini Wheel)

ITEM NAME	PART NUMBER	QUANTITY
VALVE (Ref # 16126)	16126-0735	2
ROTOR,SPEED SENSOR (Ref # 21007)	21007-0706	1
WHEEL-ASSY,FR,M.BLACK+GRN (Ref # 41073)	41073-0717-60M	1
WHEEL-ASSY,RR,M.BLACK+GRN (Ref # 41073A)	41073-0718-60M	1
DISC,FR,BLACK+BLK (Ref # 41080)	41080-0675-18U	2
SEAL-OIL,BJN-C2 32X47X5 (Ref # 92049)	92049-0050	2
SEAL-OIL,31X52X5 (Ref # 92049A)	92049-0722	1
BOLT,SOCKET,8X30 (Ref # 92154)	92154-1865	14
MARCHESINI WHEEL KIT,REAR (Ref # 99994)	99994-1008	1
MARCHESINI WHEEL KIT,FRONT (Ref # 99994A)	99994-1511	1
O RING,60MM (Ref # 671)	671B2560	1