

2024 W800 PARTS DIAGRAM

Ignition Switch/Locks/Reflectors

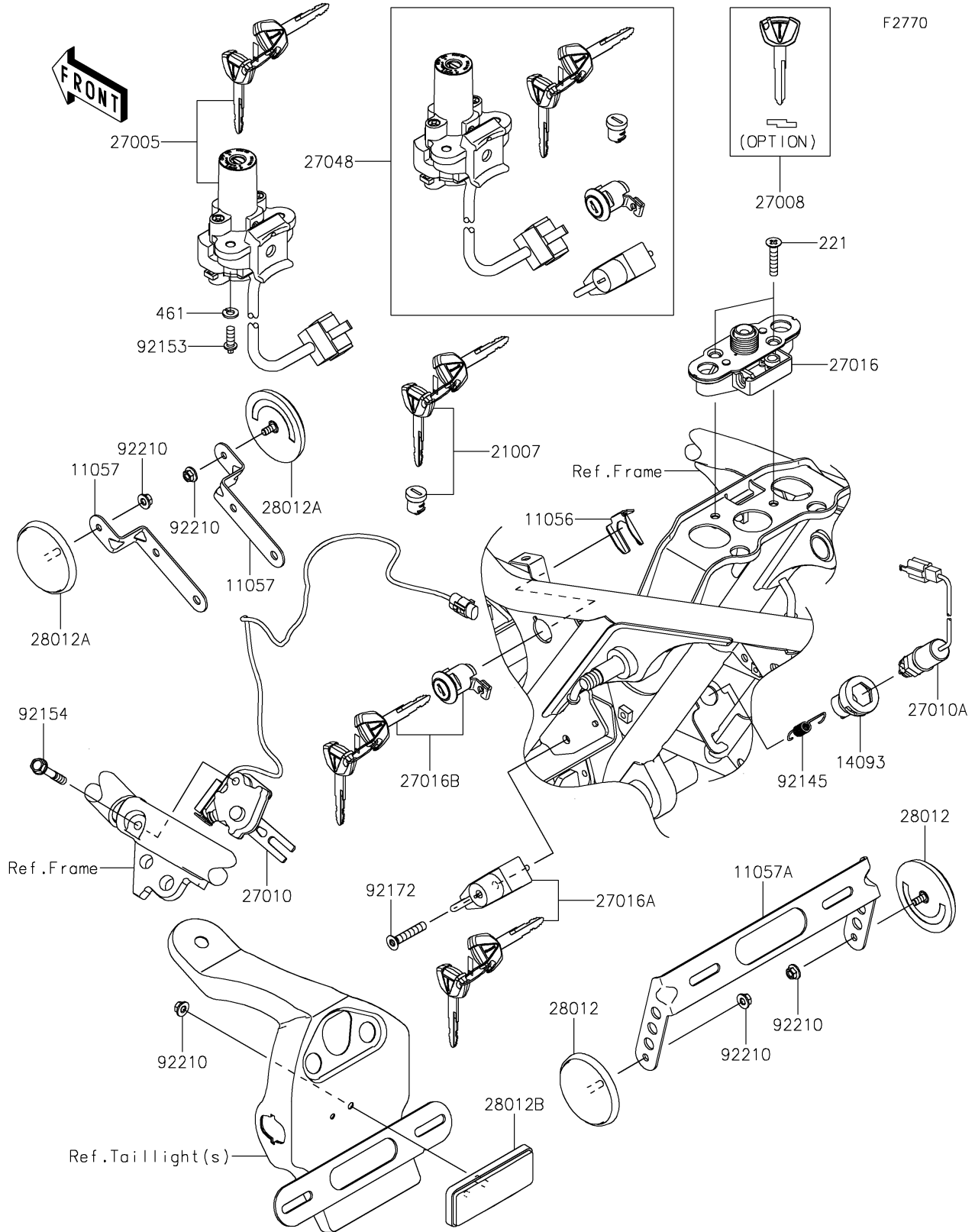

2024 W800 PARTS LIST

Ignition Switch/Locks/Reflectors

ITEM NAME	PART NUMBER	QUANTITY
BRACKET (Ref # 11056)	11056-1084	1
BRACKET,FR REFLECTOR (Ref # 11057)	11057-1989	2
BRACKET,RR REFLECTOR (Ref # 11057A)	11057-2762	1
COVER,BRAKE SW. (Ref # 14093)	14093-0666	1
ROTOR,LOCK,TANK CAP (Ref # 21007)	21007-5086	1
SWITCH-ASSY-IGNITION (Ref # 27005)	27005-0732	1
KEY-LOCK,BLANK (Ref # 27008)	27008-0648	1
SWITCH,SIDE STAND (Ref # 27010)	27010-0856	1
SWITCH,BRAKE (Ref # 27010A)	27010-0899	1
LOCK-ASSY,SEAT STRIKER (Ref # 27016)	27016-1098	1
LOCK-ASSY,HELMET (Ref # 27016A)	27016-5411	1
LOCK-ASSY,SEAT (Ref # 27016B)	27016-5412	1
SWITCH-ASSY (Ref # 27048)	27048-5316	1
REFLECTOR-REFLEX (Ref # 28012)	28012-0002	2
REFLECTOR-REFLEX (Ref # 28012A)	28012-0008	2
REFLECTOR-REFLEX (Ref # 28012B)	28012-1077	1
SPRING,BRAKE LAMP SWITCH (Ref # 92145)	92145-0761	1
BOLT,TORX,6X16 (Ref # 92153)	92153-0967	2
BOLT,FLANGED,6X40 (Ref # 92154)	92154-0859	1
SCREW,HEXLOBE,6X35 (Ref # 92172)	92172-0835	1
NUT,FLANGED,5MM (Ref # 92210)	92210-0007	5
SCREW-CSK-CROS,6X30 (Ref # 221)	221AB0630	2
WASHER-SPRING,6MM (Ref # 461)	461DA0600	2