

2025 Z H2 SE PARTS DIAGRAM

Front Master Cylinder

F2291

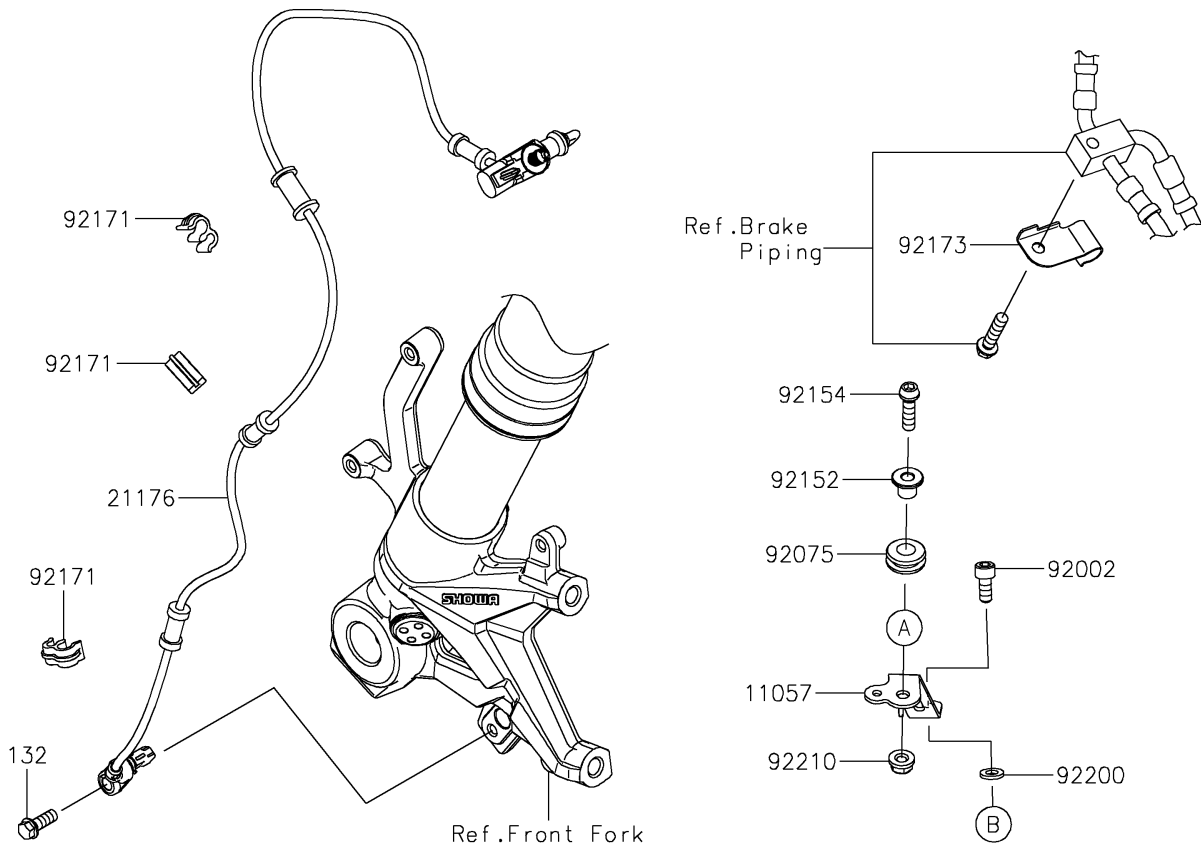
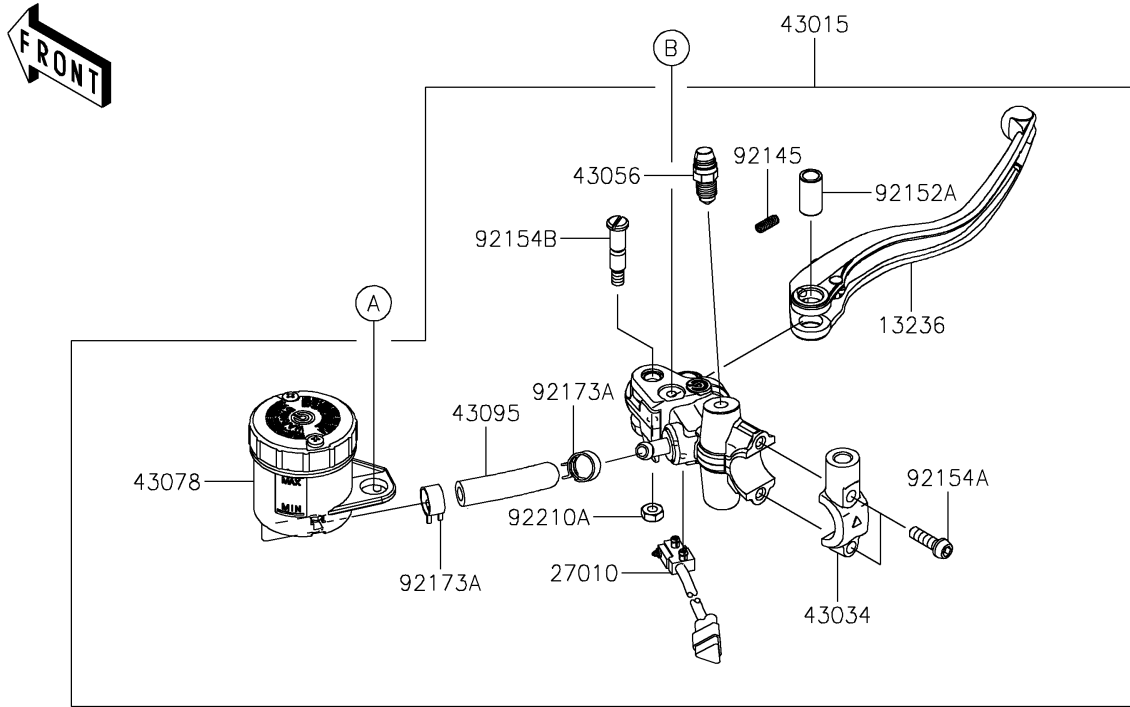

2025 Z H2 SE PARTS LIST

Front Master Cylinder

ITEM NAME	PART NUMBER	QUANTITY
BRACKET,RESERVOIR TANK (Ref # 11057)	11057-7029	1
LEVER-COMP,BRAKE (Ref # 13236)	13236-0770	1
SENSOR,FR,SPEED (Ref # 21176)	21176-1130	1
SWITCH,BRAKE (Ref # 27010)	27010-0961	1
CYLINDER-ASSY-MASTER (Ref # 43015)	43015-0789	1
HOLDER-BRAKE (Ref # 43034)	43034-0167	1
BREATHER-BRAKE (Ref # 43056)	43056-0019	1
RESERVOIR (Ref # 43078)	43078-0577	1
HOSE-BRAKE (Ref # 43095)	43095-1779	1
BOLT,SOCKET,6X14 (Ref # 92002)	92002-1592	1
DAMPER (Ref # 92075)	92075-1028	1
SPRING (Ref # 92145)	92145-1683	1
COLLAR,6X16X10.6 (Ref # 92152)	92152-2110	1
COLLAR,LEVER (Ref # 92152A)	92152-2151	1
BOLT,SOCKET,6X22 (Ref # 92154)	92154-1456	1
BOLT,SOCKET,6X20 (Ref # 92154A)	92154-1644	2
BOLT,LEVER (Ref # 92154B)	92154-1809	1
CLAMP (Ref # 92171)	92171-0921	3
CLAMP (Ref # 92173)	92173-0086	1
CLAMP,HOSE (Ref # 92173A)	92173-1498	2
WASHER,6.2X12X1.6 (Ref # 92200)	92200-0806	1
NUT,6MM (Ref # 92210)	92210-0991	1
NUT,U (Ref # 92210A)	92210-1424	1
BOLT-FLANGED-SMALL,6X16 (Ref # 132)	132BB0616	1