

2025 Z H2 SE PARTS DIAGRAM

Air Chamber

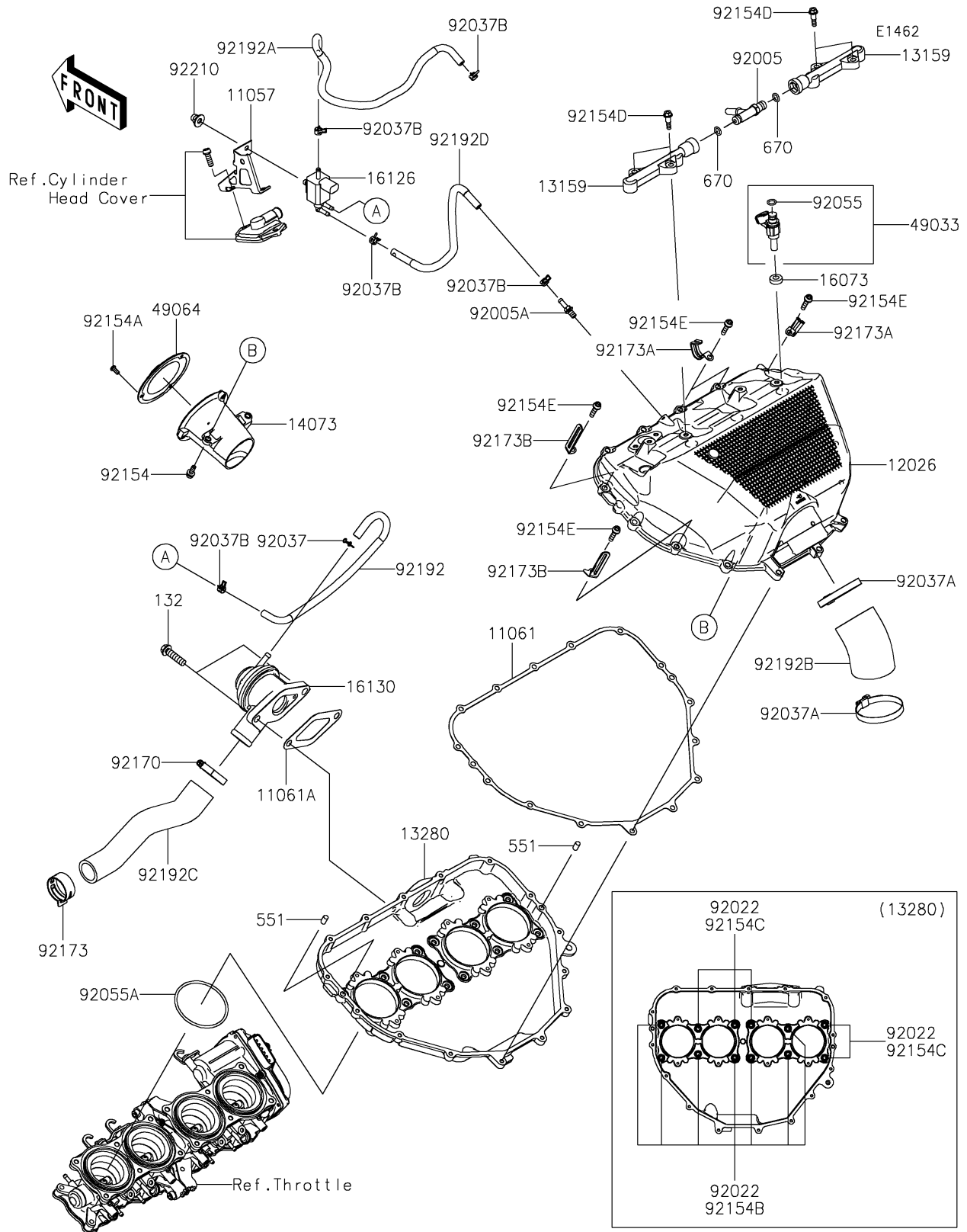

2025 Z H2 SE PARTS LIST

Air Chamber

ITEM NAME	PART NUMBER	QUANTITY
BRACKET,SOLENOID VALVE (Ref # 11057)	11057-3820	1
GASKET,CHAMBER (Ref # 11061)	11061-0949	1
GASKET,BLOWOFF VALVE (Ref # 11061A)	11061-0950	1
CHAMBER,INTAKE (Ref # 12026)	12026-0023	1
CONNECTOR (Ref # 13159)	13159-0016	2
HOLDER,CHAMBER (Ref # 13280)	13280-0905	1
DUCT,DIFFUSER (Ref # 14073)	14073-0884	1
INSULATOR (Ref # 16073)	16073-0129	4
VALVE,SOLENOID (Ref # 16126)	16126-0751	1
VALVE-ASSY-RELIEF (Ref # 16130)	16130-0010	1
NOZZLE-INJECTION (Ref # 49033)	49033-0565	4
FILTER-AIR (Ref # 49064)	49064-0007	1
FITTING (Ref # 92005)	92005-0125	1
FITTING (Ref # 92005A)	92005-0826	1
WASHER,5.5X10.5X0.8 (Ref # 92022)	92022-037	12
CLAMP,TUBE (Ref # 92037)	92037-147	1
CLAMP,RESERVE TANK (Ref # 92037A)	92037-1586	2
CLAMP,7.8MM (Ref # 92037B)	92037-2116	5
RING-O,INJECTION NOZZLE (Ref # 92055)	92055-0124	4
RING-O,65.8X3 (Ref # 92055A)	92055-0815	4
BOLT,SOCKET,5X16 (Ref # 92154)	92154-1568	2
BOLT,TORX,4X10 (Ref # 92154A)	92154-1790	3
BOLT,FLANGED,5X14 (Ref # 92154B)	92154-3884	7
BOLT,FLANGED,5X95 (Ref # 92154C)	92154-3886	5
BOLT,SHOULDER,5X20 (Ref # 92154D)	92154-3971	4
BOLT,SOCKET,5X22 (Ref # 92154E)	92154-4055	15
CLAMP (Ref # 92170)	92170-1036	1
CLAMP,35.5MM (Ref # 92173)	92173-1432	1
CLAMP (Ref # 92173A)	92173-2305	3

2025 Z H2 SE PARTS LIST

Air Chamber

ITEM NAME	PART NUMBER	QUANTITY
CLAMP (Ref # 92173B)	92173-2307	2
TUBE,SOLENOID-BLOWOFF VALVE (Ref # 92192)	92192-1841	1
TUBE,SOLENOID-THROTTLE BODY (Ref # 92192A)	92192-1842	1
TUBE,DIFFUSER (Ref # 92192B)	92192-1865	1
TUBE,BLOWOFF VALVE-AIR FILTER (Ref # 92192C)	92192-2290	1
TUBE,SOLENOID-CHAMBER (Ref # 92192D)	92192-2497	1
NUT,CAP,6MM (Ref # 92210)	92210-0170	1
BOLT-FLANGED-SMALL,8X30 (Ref # 132)	132BC0830	2
PIN-DOWEL,6X12 (Ref # 551)	551A0612	2
O RING,8MM (Ref # 670)	670E1508	2