

2025 Z H2 SE PARTS DIAGRAM

Valve(s)

E1210

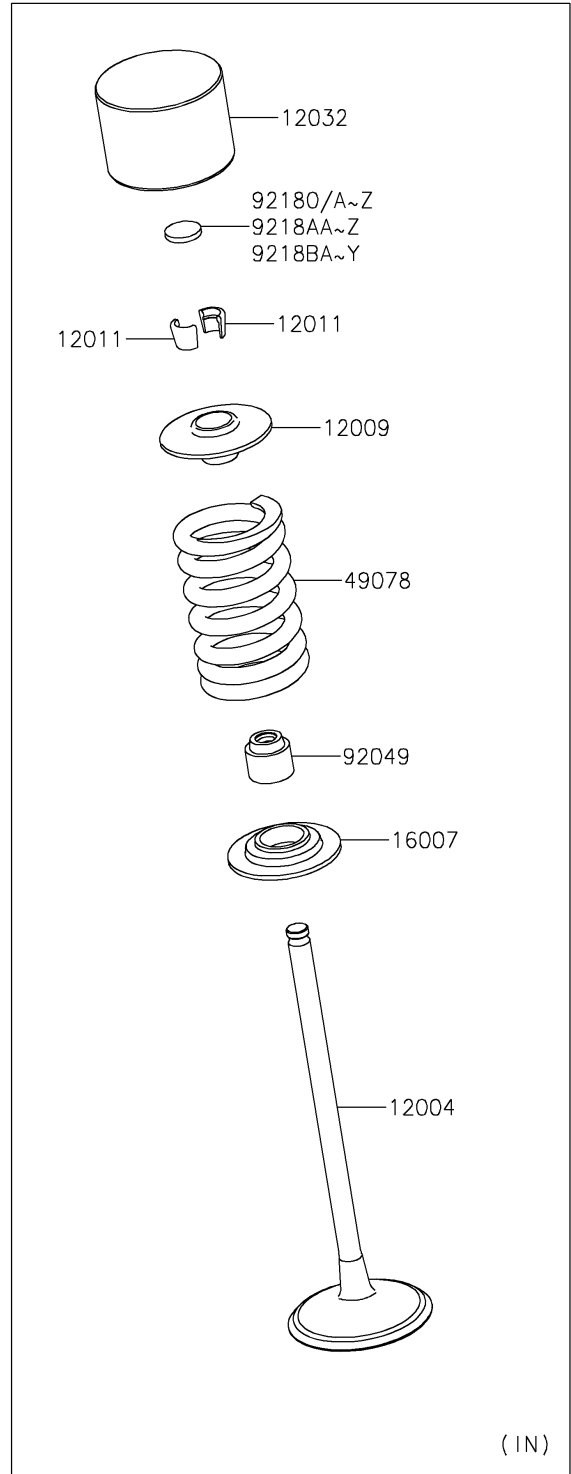
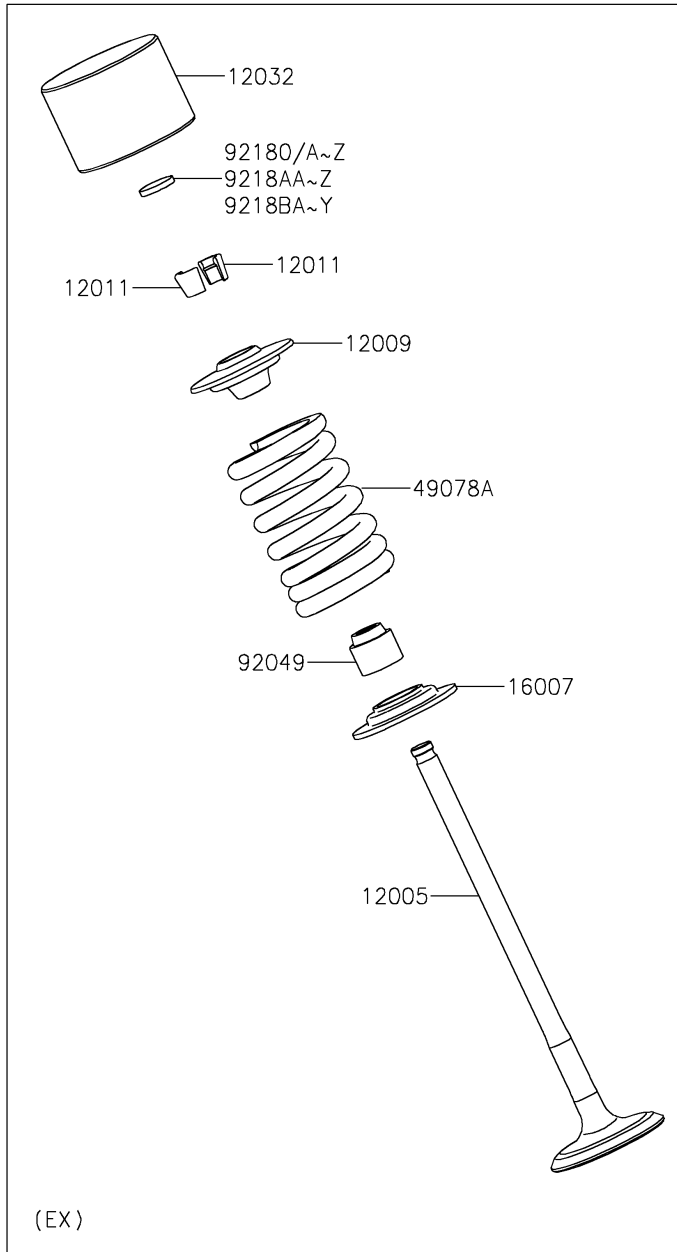

2025 Z H2 SE PARTS LIST

Valve(s)

ITEM NAME	PART NUMBER	QUANTITY
VALVE-INTAKE (Ref # 12004)	12004-0744	8
VALVE-EXHAUST (Ref # 12005)	12005-0765	8
RETAINER-VALVE SPRING (Ref # 12009)	12009-0031	16
COLLET (Ref # 12011)	12011-1053	32
TAPPET,D26.5 (Ref # 12032)	12032-0013	16
SEAT-SPRING (Ref # 16007)	16007-0034	16
SPRING-ENGINE VALVE,INTAKE (Ref # 49078)	49078-0744	8
SPRING-ENGINE VALVE,EXHAUST (Ref # 49078A)	49078-0745	8
SEAL-OIL,VSB 4.3 7.5 5.3 8.3 (Ref # 92049)	92049-1349	16
SHIM,T=1.300 (Ref # 92180)	92180-0108	AR
SHIM,T=1.325 (Ref # 92180A)	92180-0109	AR
SHIM,T=1.350 (Ref # 92180B)	92180-0110	AR
SHIM,T=1.375 (Ref # 92180C)	92180-0865	AR
SHIM,T=1.388 (Ref # 92180D)	92180-0866	AR
SHIM,T=1.400 (Ref # 92180E)	92180-0867	AR
SHIM,T=1.413 (Ref # 92180F)	92180-0868	AR
SHIM,T=1.425 (Ref # 92180G)	92180-0869	AR
SHIM,T=1.438 (Ref # 92180H)	92180-0870	AR
SHIM,T=1.450 (Ref # 92180I)	92180-0871	AR
SHIM,T=1.463 (Ref # 92180J)	92180-0872	AR
SHIM,T=1.475 (Ref # 92180K)	92180-0873	AR
SHIM,T=1.488 (Ref # 92180L)	92180-0874	AR
SHIM,T=1.500 (Ref # 92180M)	92180-0875	AR
SHIM,T=1.513 (Ref # 92180N)	92180-0876	AR
SHIM,T=1.525 (Ref # 92180O)	92180-0877	AR
SHIM,T=1.538 (Ref # 92180P)	92180-0878	AR
SHIM,T=1.550 (Ref # 92180Q)	92180-0879	AR
SHIM,T=1.563 (Ref # 92180R)	92180-0880	AR
SHIM,T=1.575 (Ref # 92180S)	92180-0881	AR

2025 Z H2 SE PARTS LIST

Valve(s)

ITEM NAME	PART NUMBER	QUANTITY
SHIM,T=1.588 (Ref # 92180T)	92180-0882	AR
SHIM,T=1.600 (Ref # 92180U)	92180-0883	AR
SHIM,T=1.613 (Ref # 92180V)	92180-0884	AR
SHIM,T=1.625 (Ref # 92180W)	92180-0885	AR
SHIM,T=1.638 (Ref # 92180X)	92180-0886	AR
SHIM,T=1.650 (Ref # 92180Y)	92180-0887	AR
SHIM,T=1.663 (Ref # 92180Z)	92180-0888	AR
SHIM,T=1.675 (Ref # 9218AA)	92180-0889	AR
SHIM,T=1.688 (Ref # 9218AB)	92180-0890	AR
SHIM,T=1.700 (Ref # 9218AC)	92180-0891	AR
SHIM,T=1.713 (Ref # 9218AD)	92180-0892	AR
SHIM,T=1.725 (Ref # 9218AE)	92180-0893	AR
SHIM,T=1.738 (Ref # 9218AF)	92180-0894	AR
SHIM,T=1.750 (Ref # 9218AG)	92180-0895	AR
SHIM,T=1.763 (Ref # 9218AH)	92180-0896	AR
SHIM,T=1.775 (Ref # 9218AI)	92180-0897	AR
SHIM,T=1.788 (Ref # 9218AJ)	92180-0898	AR
SHIM,T=1.800 (Ref # 9218AK)	92180-0899	16
SHIM,T=1.813 (Ref # 9218AL)	92180-0900	AR
SHIM,T=1.825 (Ref # 9218AM)	92180-0901	AR
SHIM,T=1.838 (Ref # 9218AN)	92180-0902	AR
SHIM,T=1.850 (Ref # 9218AO)	92180-0903	AR
SHIM,T=1.863 (Ref # 9218AP)	92180-0904	AR
SHIM,T=1.875 (Ref # 9218AQ)	92180-0905	AR
SHIM,T=1.888 (Ref # 9218AR)	92180-0906	AR
SHIM,T=1.900 (Ref # 9218AS)	92180-0907	AR
SHIM,T=1.913 (Ref # 9218AT)	92180-0908	AR
SHIM,T=1.925 (Ref # 9218AU)	92180-0909	AR
SHIM,T=1.938 (Ref # 9218AV)	92180-0910	AR

2025 Z H2 SE PARTS LIST

Valve(s)

ITEM NAME	PART NUMBER	QUANTITY
SHIM,T=1.950 (Ref # 9218AW)	92180-0911	AR
SHIM,T=1.963 (Ref # 9218AX)	92180-0912	AR
SHIM,T=1.975 (Ref # 9218AY)	92180-0913	AR
SHIM,T=1.988 (Ref # 9218AZ)	92180-0914	AR
SHIM,T=2.000 (Ref # 9218BA)	92180-0915	AR
SHIM,T=2.013 (Ref # 9218BB)	92180-0916	AR
SHIM,T=2.025 (Ref # 9218BC)	92180-0917	AR
SHIM,T=2.038 (Ref # 9218BD)	92180-0918	AR
SHIM,T=2.050 (Ref # 9218BE)	92180-0919	AR
SHIM,T=2.063 (Ref # 9218BF)	92180-0920	AR
SHIM,T=2.075 (Ref # 9218BG)	92180-0921	AR
SHIM,T=2.088 (Ref # 9218BH)	92180-0922	AR
SHIM,T=2.100 (Ref # 9218BI)	92180-0923	AR
SHIM,T=2.113 (Ref # 9218BJ)	92180-0924	AR
SHIM,T=2.125 (Ref # 9218BK)	92180-0925	AR
SHIM,T=2.138 (Ref # 9218BL)	92180-0926	AR
SHIM,T=2.150 (Ref # 9218BM)	92180-0927	AR
SHIM,T=2.163 (Ref # 9218BN)	92180-0928	AR
SHIM,T=2.175 (Ref # 9218BO)	92180-0929	AR
SHIM,T=2.188 (Ref # 9218BP)	92180-0930	AR
SHIM,T=2.200 (Ref # 9218BQ)	92180-0931	AR
SHIM,T=2.213 (Ref # 9218BR)	92180-0932	AR
SHIM,T=2.225 (Ref # 9218BS)	92180-0933	AR
SHIM,T=2.238 (Ref # 9218BT)	92180-0934	AR
SHIM,T=2.250 (Ref # 9218BU)	92180-0935	AR
SHIM,T=2.263 (Ref # 9218BV)	92180-0936	AR
SHIM,T=2.275 (Ref # 9218BW)	92180-0937	AR
SHIM,T=2.288 (Ref # 9218BX)	92180-0938	AR
SHIM,T=2.300 (Ref # 9218BY)	92180-0939	AR