

1997 GPZ 1100 PARTS DIAGRAM

Footrests

F2160

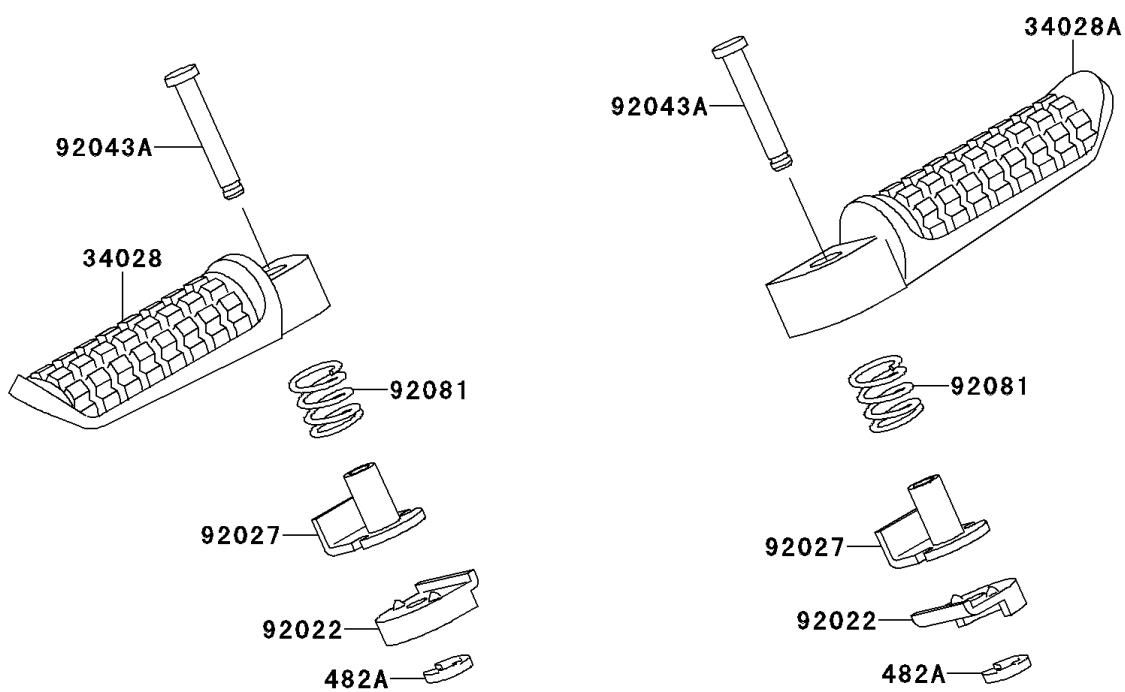
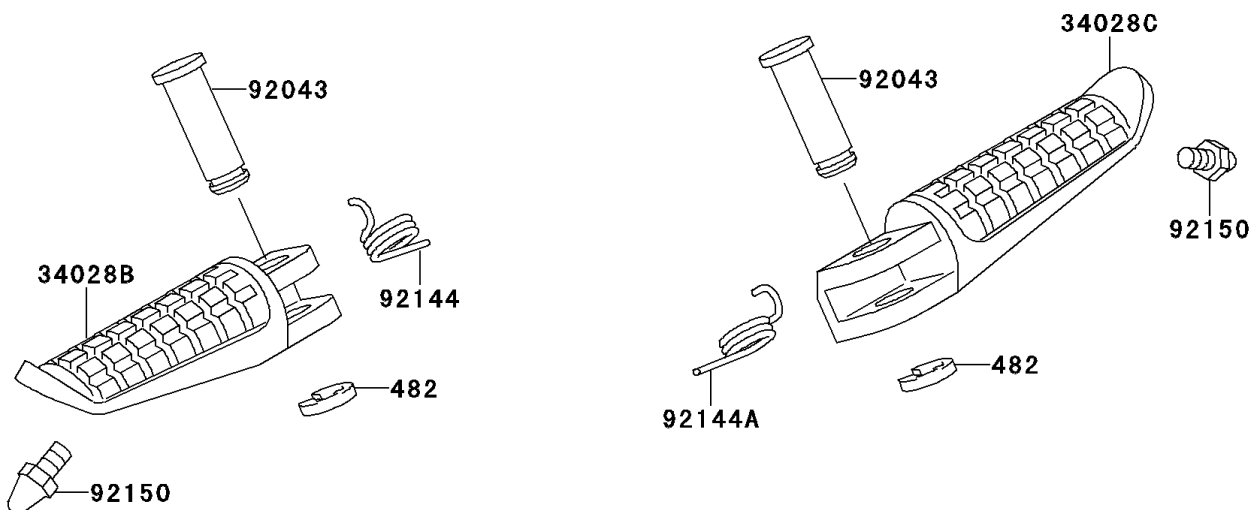

1997 GPZ 1100 PARTS LIST

Footrests

ITEM NAME	PART NUMBER	QUANTITY
CIRCLIP-TYPE-E,10MM (Ref # 482)	482L0100	1
CIRCLIP-TYPE-E,5MM (Ref # 482A)	482L5000	1
STEP,RR,LH (Ref # 34028)	34028-1191	1
STEP,RR,RH (Ref # 34028A)	34028-1192	1
STEP,FR,LH (Ref # 34028B)	34028-1334	1
STEP,FR,RH (Ref # 34028C)	34028-1335	1
WASHER,STEP,RR (Ref # 92022)	92022-1507	1
COLLAR,STEP (Ref # 92027)	92027-1732	1
PIN,12X37 (Ref # 92043)	92043-1144	1
PIN,6X38.5 (Ref # 92043A)	92043-1238	1
SPRING,STEP,RR (Ref # 92081)	92081-1612	1
SPRING,STEP RETURN,LH (Ref # 92144)	92144-1567	1
SPRING,STEP RETURN (Ref # 92144A)	92144-1568	1
BOLT,BANK SENSOR (Ref # 92150)	92150-1114	1