

1997 GPZ 1100 PARTS DIAGRAM

Rear Suspension

F2150

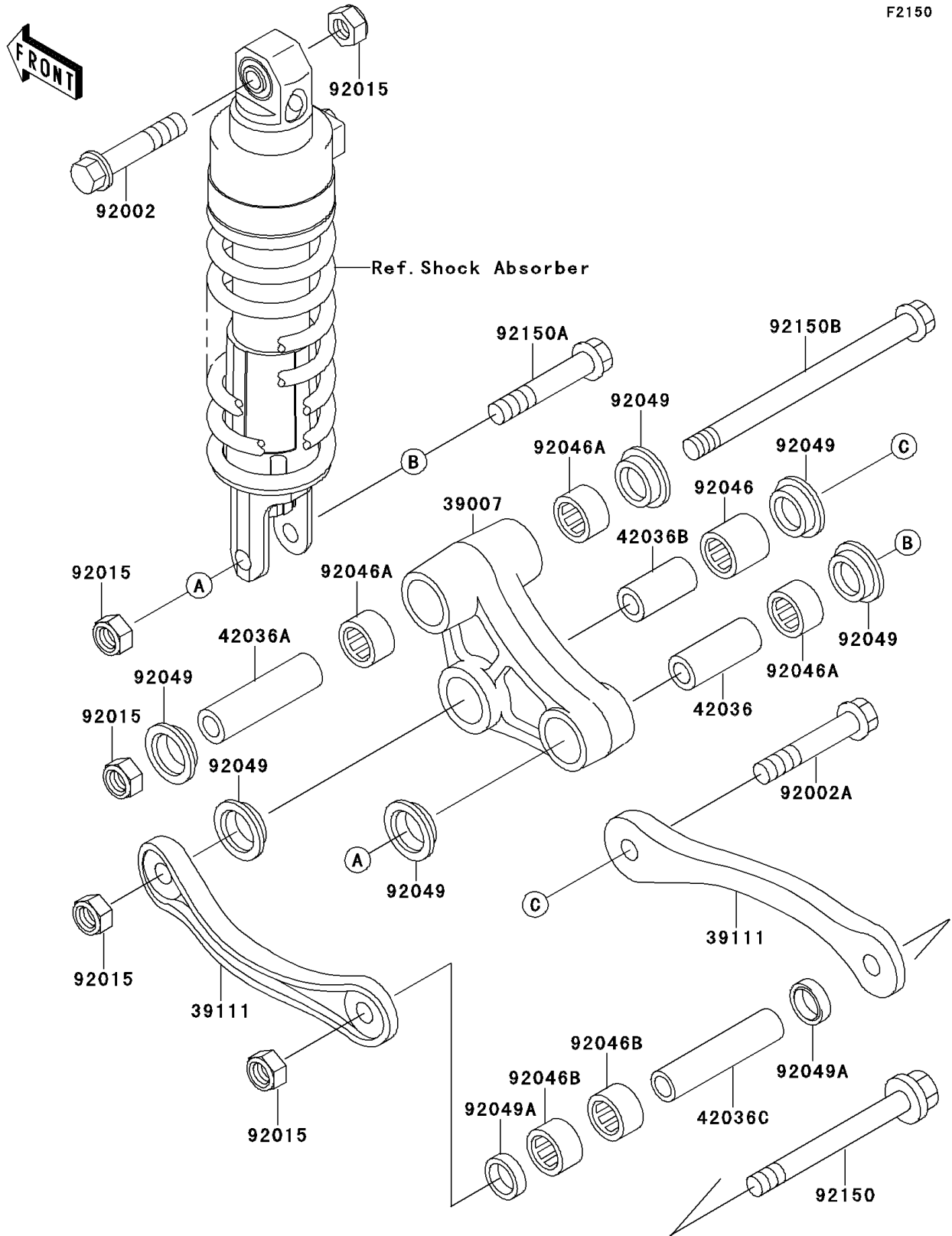

1997 GPZ 1100 PARTS LIST

Rear Suspension

ITEM NAME	PART NUMBER	QUANTITY
ARM-SUSP,UNI TRAK (Ref # 39007)	39007-1238	1
ROD-TIE,SUSPENSION (Ref # 39111)	39111-1140	1
SLEEVE,ARM,RR (Ref # 42036)	42036-1077	1
SLEEVE,ARM,CNT (Ref # 42036A)	42036-1079	1
SLEEVE,12.1X20X50 (Ref # 42036B)	42036-1111	1
SLEEVE,12.1X18X82 (Ref # 42036C)	42036-1231	1
BOLT,12X55 (Ref # 92002)	92002-1130	1
BOLT,SUSPENSION ARM,12MM (Ref # 92002A)	92002-1785	1
NUT,LOCK,12MM,BLACK (Ref # 92015)	92015-1190	1
BEARING-NEEDLE,BM202726 (Ref # 92046)	92046-1110	1
BEARING-NEEDLE,BM202715 (Ref # 92046A)	92046-1112	1
BEARING-NEEDLE,18BM2416 (Ref # 92046B)	92046-1144	1
SEAL-OIL,ARM,CNT (Ref # 92049)	92049-1109	1
SEAL-OIL,MHA18244 (Ref # 92049A)	92049-1225	1
BOLT,FLANGED,12X110 (Ref # 92150)	92150-1088	1
BOLT,FLANGED,12X63 (Ref # 92150A)	92150-1258	1
BOLT,FLANGED,12X165 (Ref # 92150B)	92150-1931	1