

1995 GPZ 1100 PARTS DIAGRAM

Swingarm

F2141

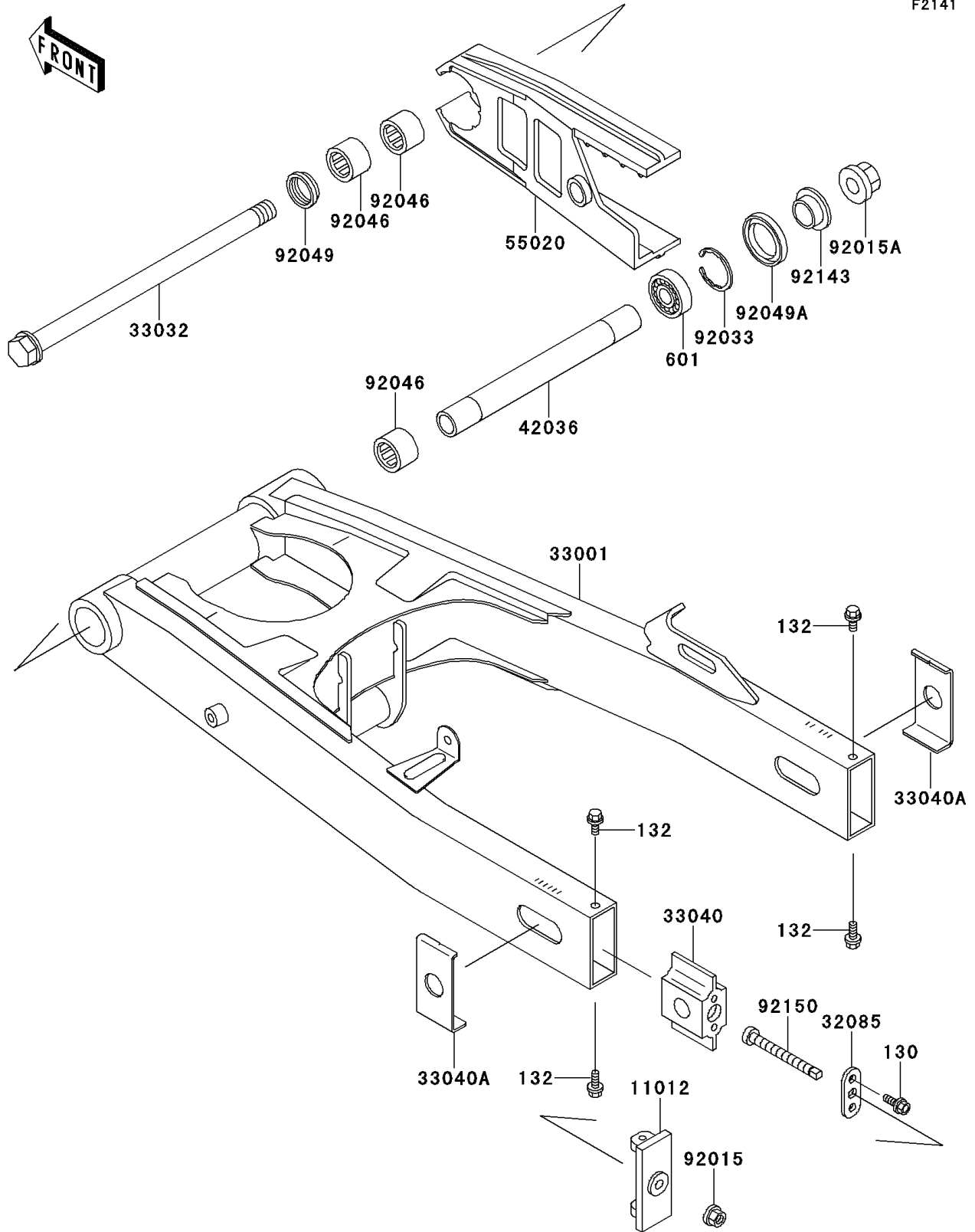

1995 GPZ 1100 PARTS LIST

Swingarm

ITEM NAME	PART NUMBER	QUANTITY
BOLT-FLANGED (Ref # 130)	130P0616	1
BOLT-FLANGED-SMALL (Ref # 132)	132J0612	1
BEARING-BALL,#6004 (Ref # 601)	601A6004	1
CAP,CHAIN ADJUSTER (Ref # 11012)	11012-1911	1
STOPPER,CHAIN ADJUSTER (Ref # 32085)	32085-1408	1
ARM-COMP-SWING (Ref # 33001)	33001-1474	1
SHAFT-SWING ARM (Ref # 33032)	33032-1170	1
ADJUSTER-CHAIN,INNER (Ref # 33040)	33040-1142	1
ADJUSTER-CHAIN,OUTER (Ref # 33040A)	33040-1143	1
SLEEVE,SWING ARM,L=227.2 (Ref # 42036)	42036-1236	1
GUARD,CHAIN (Ref # 55020)	55020-1529	1
NUT,FLANGED,8MM,BLACK (Ref # 92015)	92015-1183	1
NUT,FLANGED,20MM (Ref # 92015A)	92015-1724	1
RING-SNAP,42MM (Ref # 92033)	92033-1041	1
BEARING-NEEDLE,BM2817 (Ref # 92046)	92046-1111	1
SEAL-OIL (Ref # 92049)	92049-1181	1
SEAL-OIL,TC28426.5 (Ref # 92049A)	92049-1185	1
COLLAR,SWING ARM,RH,L=12.5 (Ref # 92143)	92143-1727	1
BOLT,CHAIN ADJUSTER (Ref # 92150)	92150-1285	1