

2024 Ninja® 650 PARTS DIAGRAM

Chassis Electrical Equipment

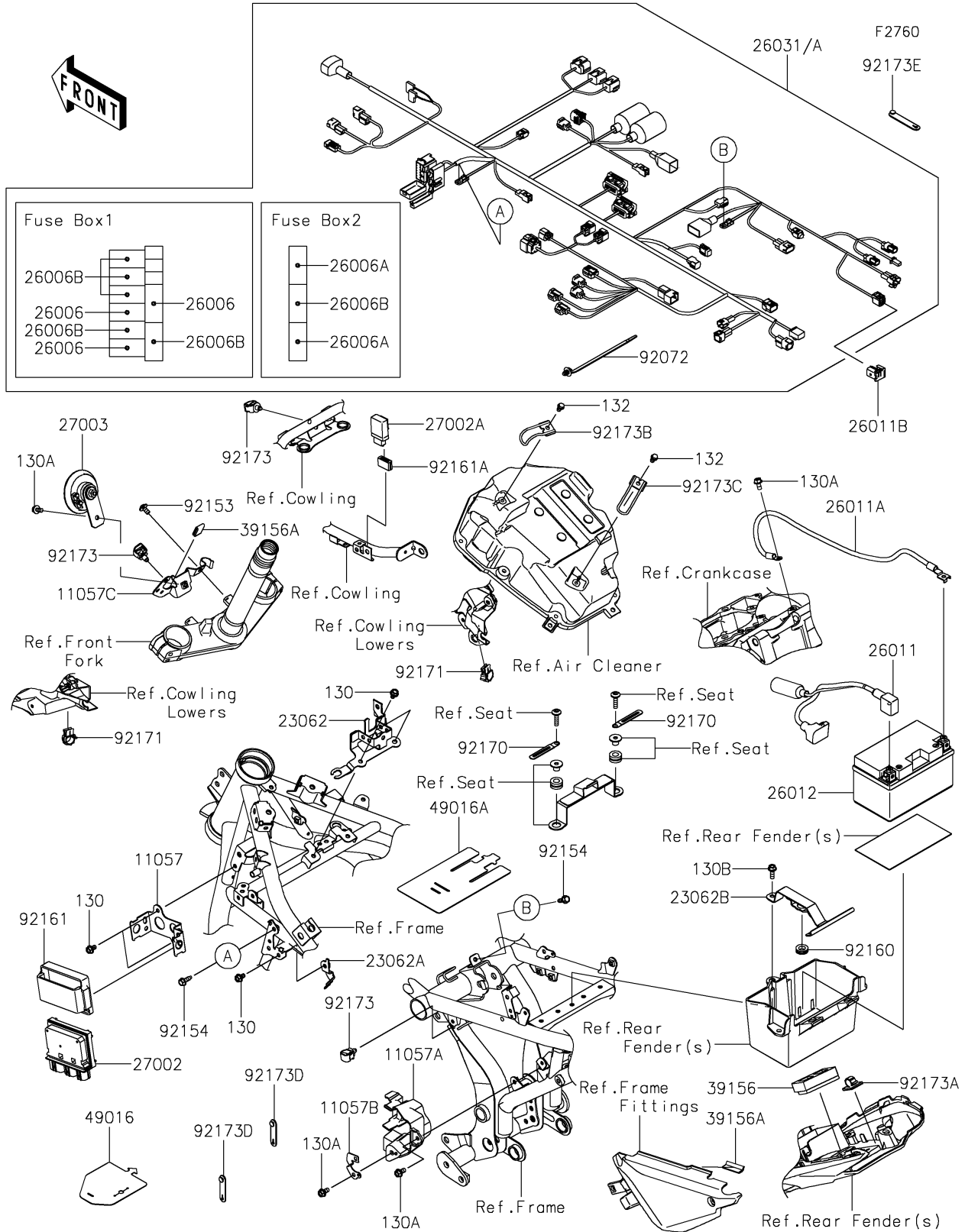

2024 Ninja® 650 PARTS LIST

Chassis Electrical Equipment

ITEM NAME	PART NUMBER	QUANTITY
BRACKET,RELAY BOX (Ref # 11057)	11057-0122	1
BRACKET,MAGNETIC SW. (Ref # 11057A)	11057-0137	1
BRACKET,COUPLER (Ref # 11057B)	11057-0138	1
BRACKET,HORN (Ref # 11057C)	11057-0184	1
BRACKET,VEHICLE DOWN SENSOR (Ref # 23062)	23062-1258	1
BRACKET-COMP,FUSE BOX (Ref # 23062A)	23062-1259	1
BRACKET-COMP,BATTERY (Ref # 23062B)	23062-1269	1
FUSE,MINI BLADE,15A,BLUE (Ref # 26006)	26006-0001	3
FUSE,MINI BLADE,5A,TAN (Ref # 26006A)	26006-1077	2
FUSE,MINI BLADE,10A,RED (Ref # 26006B)	26006-1078	6
WIRE-LEAD,BATTERY(+) (Ref # 26011)	26011-0979	1
WIRE-LEAD,BATTERY(-) (Ref # 26011A)	26011-0981	1
WIRE-LEAD,DIAG CONNECTOR (Ref # 26011B)	26011-1901	1
BATTERY,YTZ10,12V 8.6AH (Ref # 26012)	26012-0689	1
HARNESS,MAIN (Ref # 26031)	26031-3874	1
HARNESS,MAIN (Ref # 26031A)	26031-3875	1
RELAY-ASSY (Ref # 27002)	27002-0061	1
RELAY-ASSY,SIGNAL LAMP (Ref # 27002A)	27002-0062	1
HORN (Ref # 27003)	27003-0065	1
PAD,DIAGNOSTIC-CONNECTOR (Ref # 39156)	39156-2627	1
PAD,40X15X2 (Ref # 39156A)	39156-2639	2
COVER-SEAL (Ref # 49016)	49016-0645	1
COVER-SEAL,ECU CONNECTOR (Ref # 49016A)	49016-0672	1
BAND,OS170-FT7(BLACK) (Ref # 92072)	92072-1414	AR
BOLT,SOCKET,6X12 (Ref # 92153)	92153-1948	2
BOLT,FLANGED,6X18 (Ref # 92154)	92154-4008	2
DAMPER (Ref # 92160)	92160-1278	1
DAMPER,RELAY BOX (Ref # 92161)	92161-0203	1
DAMPER,15X25X8.5 (Ref # 92161A)	92161-1443	1

2024 Ninja® 650 PARTS LIST

Chassis Electrical Equipment

ITEM NAME	PART NUMBER	QUANTITY
CLAMP (Ref # 92170)	92170-1514	2
CLAMP,EDGE CLIP (Ref # 92171)	92171-1722	2
CLAMP,12MM DIA. (Ref # 92173)	92173-0736	3
CLAMP,DRAIN (Ref # 92173A)	92173-1055	1
CLAMP,A/C CASE,FR (Ref # 92173B)	92173-1586	1
CLAMP,A/C CASE,RR (Ref # 92173C)	92173-1587	1
CLAMP (Ref # 92173D)	92173-2198	2
CLAMP (Ref # 92173E)	92173-2199	3
BOLT-FLANGED,6X10 (Ref # 130)	130BA0610	5
BOLT-FLANGED,6X12 (Ref # 130A)	130BA0612	4
BOLT-FLANGED,6X18 (Ref # 130B)	130BA0618	1
BOLT-FLANGED-SMALL,6X10 (Ref # 132)	132BA0610	2