

1993 Ninja® ZX™ -11 PARTS DIAGRAM

Breather Cover/Oil Pan

E1432

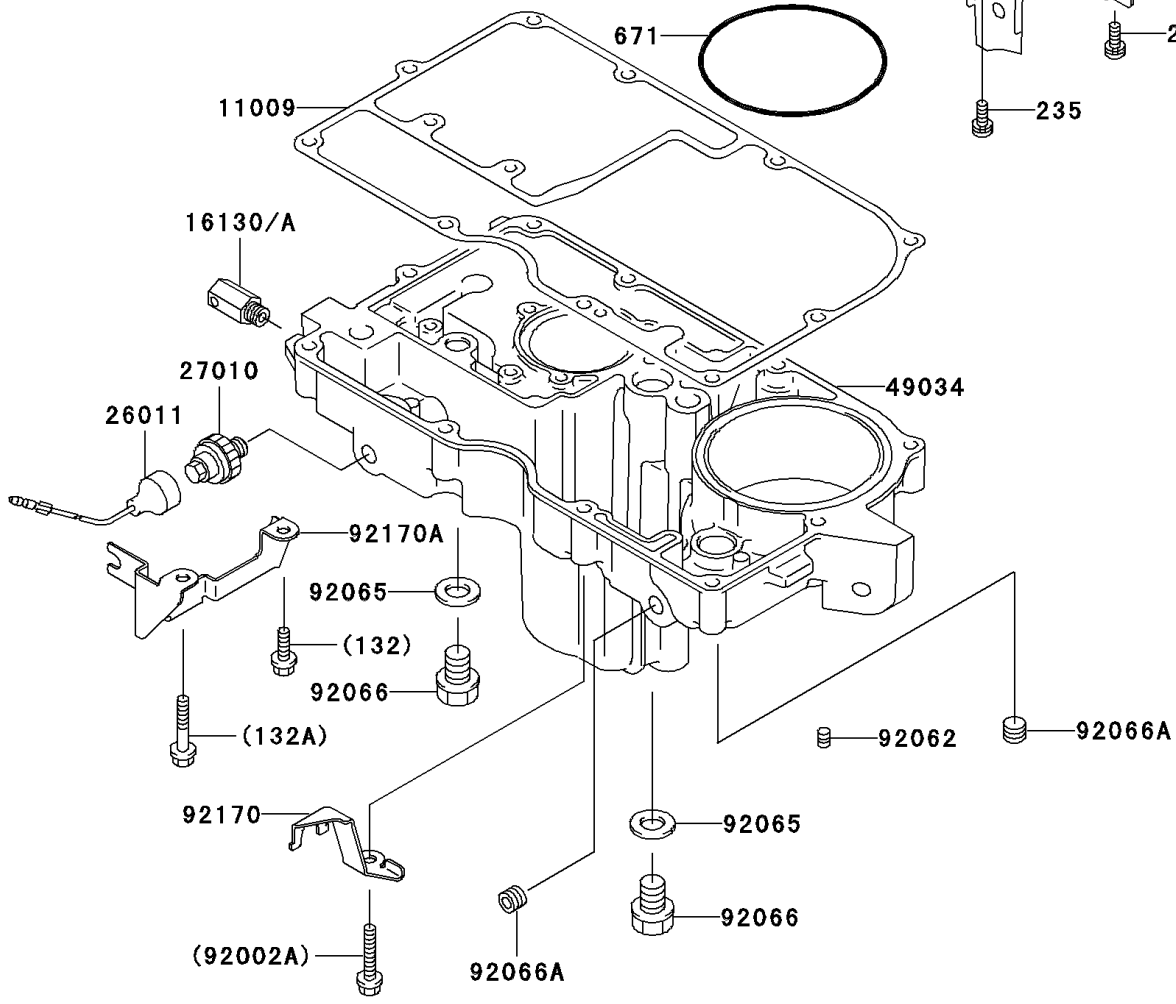
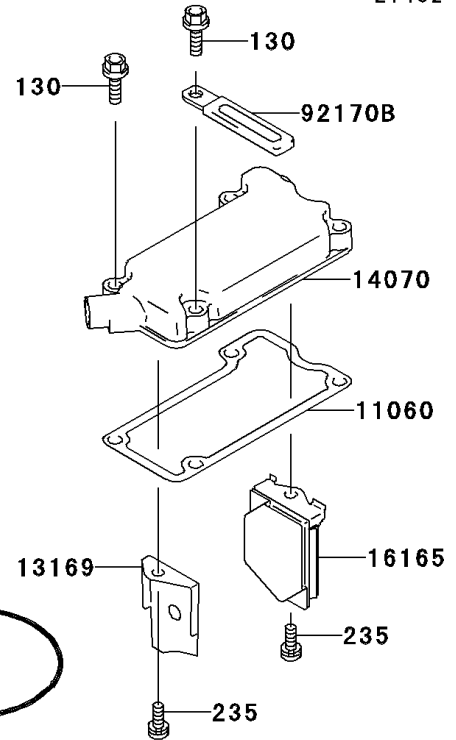
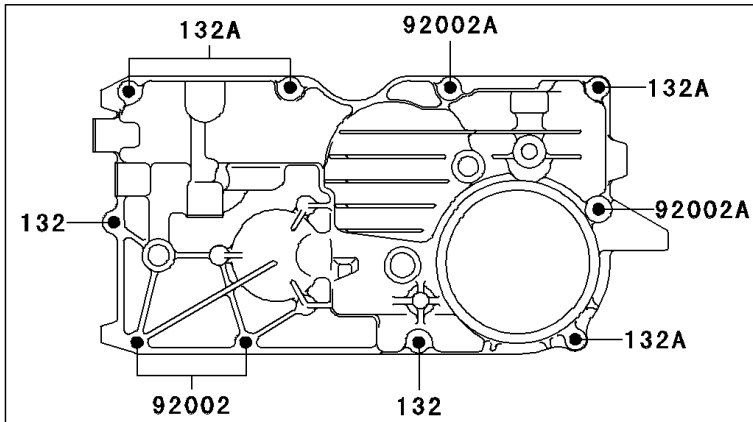

1993 Ninja® ZX™ -11 PARTS LIST

Breather Cover/Oil Pan

ITEM NAME	PART NUMBER	QUANTITY
BOLT-FLANGED,6X25 (Ref # 130)	130P0625	4
BOLT-FLANGED-SMALL (Ref # 132)	132J0625	2
BOLT-FLANGED-SMALL,6X40 (Ref # 132A)	132J0640	4
SCREW-PAN-WP-CROS (Ref # 235)	235B0610	2
O RING,90MM (Ref # 671)	671B2590	1
GASKET,OIL PAN (Ref # 11009)	11009-1981	1
GASKET,BREATHER BODY (Ref # 11060)	11060-1339	1
PLATE,BREATHER (Ref # 13169)	13169-1967	1
BODY-BREATHER (Ref # 14070)	14070-1072	1
VALVE-ASSY-RELIEF (Ref # 16130)	16130-1001	1
SEPARATOR,OIL (Ref # 16165)	16165-1053	1
WIRE-LEAD (Ref # 26011)	26011-1371	1
SWITCH,OIL PRESSURE (Ref # 27010)	27010-1313	1
PAN-OIL (Ref # 49034)	49034-1118	1
BOLT,6X25 (Ref # 92002)	92002-1344	2
BOLT,6X40 (Ref # 92002A)	92002-1345	2
NOZZLE,6X8,BLACK (Ref # 92062)	92062-1079	1
GASKET,12X22X2,DRAIN PLUG (Ref # 92065)	92065-097	2
PLUG,OIL DRAIN,12X15 (Ref # 92066)	92066-1174	2
PLUG,OIL LINE,1/8X7 (Ref # 92066A)	92066-1342	2
CLAMP,OIL TUBE (Ref # 92170)	92170-1188	1
CLAMP,OIL TUBE (Ref # 92170A)	92170-1189	1
CLAMP (Ref # 92170B)	92170-1514	1