

1992 Ninja® ZX™-11 PARTS DIAGRAM

Side Cover/Chain Case

F2610

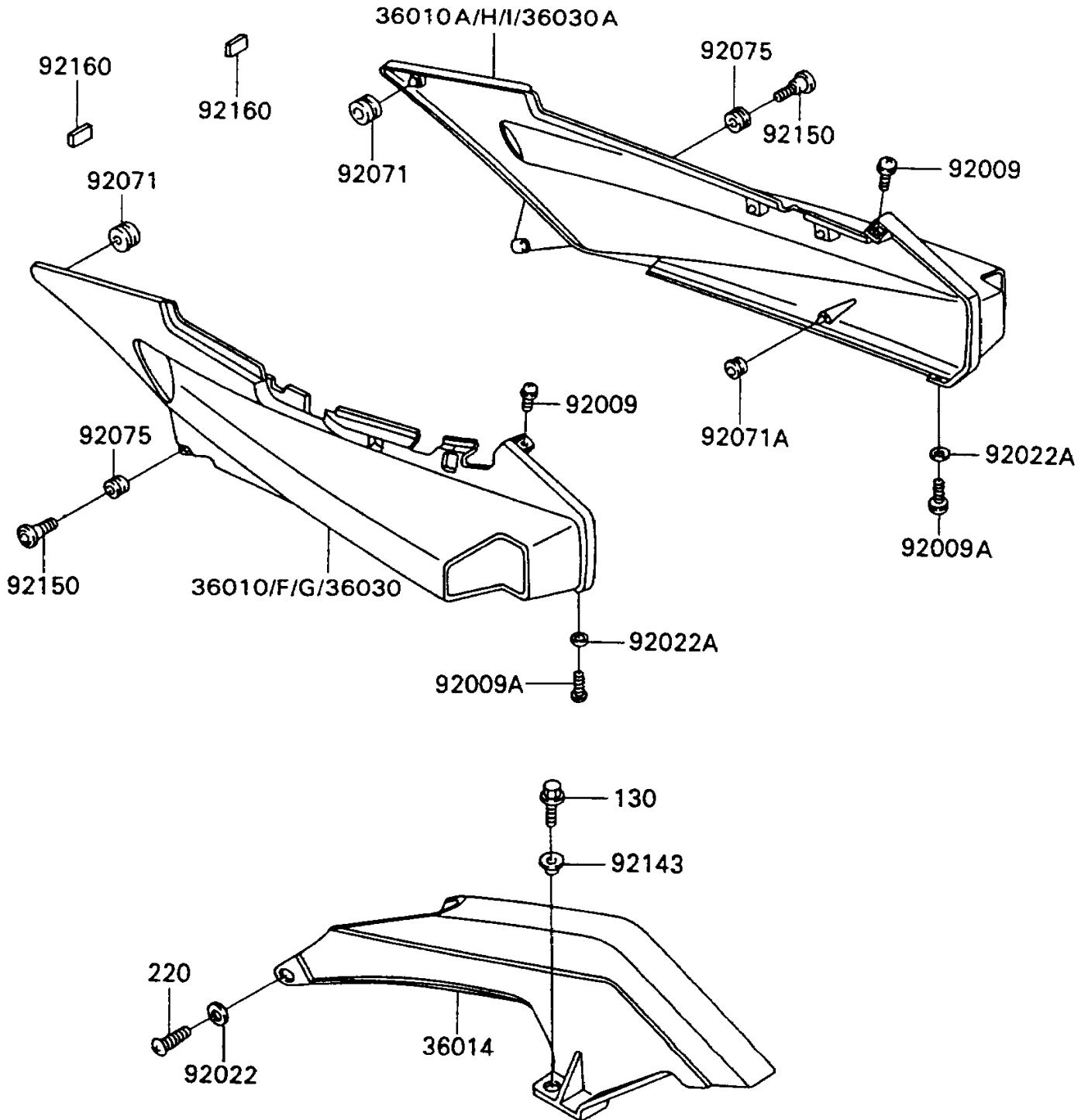

1992 Ninja® ZX™-11 PARTS LIST

Side Cover/Chain Case

ITEM NAME	PART NUMBER	QUANTITY
CASE-CHAIN (Ref # 36014)	36014-1170	1
COVER-SIDE,LH,EBONY (Ref # 36030)	36030-5029-H8	1
COVER-SIDE,RH,EBONY (Ref # 36030A)	36030-5030-H8	1
SCREW,6X18,BLACK (Ref # 92009)	92009-1181	1
SCREW,5X20 (Ref # 92009A)	92009-1656	1
WASHER,6.5X20X1.6,BLACK (Ref # 92022)	92022-1346	1
WASHER,NYLON,5.3X11.5X1.5 (Ref # 92022A)	92022-1521	1
GROMMET (Ref # 92071)	92071-056	1
GROMMET (Ref # 92071A)	92071-1131	1
DAMPER (Ref # 92075)	92075-1634	1
COLLAR,L=6.6 (Ref # 92143)	92143-1088	1
BOLT,SOCKET,6MM (Ref # 92150)	92150-1154	1
DAMPER (Ref # 92160)	92160-1190	1
BOLT-FLANGED,6X14,BLACK (Ref # 130)	130J0614	1
SCREW-PAN-CROS,6X16,BLACK (Ref # 220)	220C0616	1