

1992 Ninja® ZX™ -11 PARTS DIAGRAM

Swing Arm

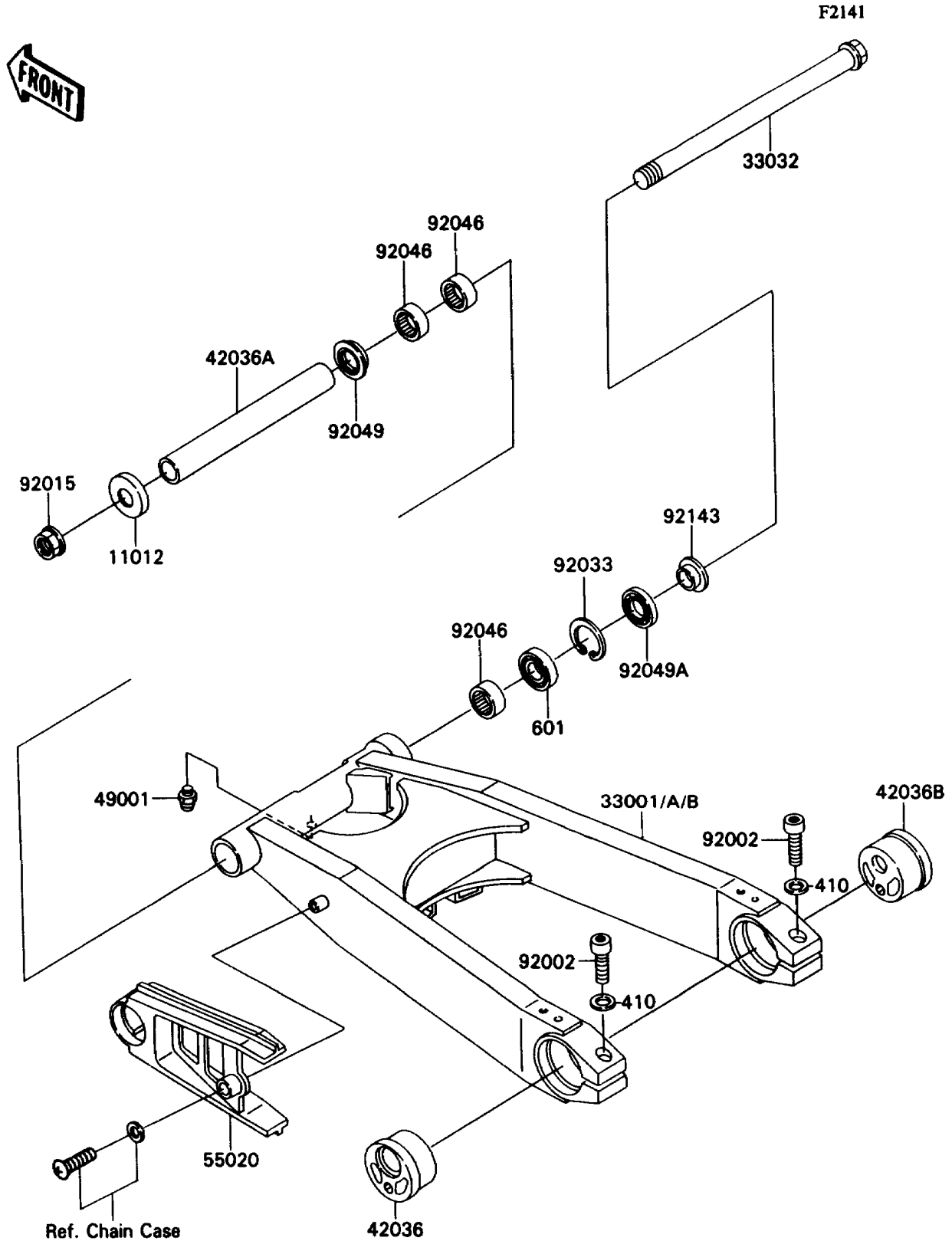

1992 Ninja® ZX™ -11 PARTS LIST

Swing Arm

ITEM NAME	PART NUMBER	QUANTITY
CAP (Ref # 11012)	11012-1658	1
ARM-COMP-SWING,BLACK (Ref # 33001B)	33001-1351-10	1
SHAFT-SWING ARM (Ref # 33032)	33032-1157	1
SLEEVE,REAR AXLE,LH (Ref # 42036)	42036-1153	1
SLEEVE,SWING ARM,L=237 (Ref # 42036A)	42036-1264	1
SLEEVE,REAR AXLE,RH (Ref # 42036B)	42036-1265	1
NIPPLE-GREASE (Ref # 49001)	49001-1051	1
GUARD,CHAIN (Ref # 55020)	55020-1365	1
BOLT,SOCKET,10X40 (Ref # 92002)	92002-1452	2
NUT,FLANGED,20MM (Ref # 92015)	92015-1724	1
RING-SNAP,42MM (Ref # 92033)	92033-1041	1
BEARING-NEEDLE,BM283417 (Ref # 92046)	92046-1111	3
SEAL-OIL (Ref # 92049)	92049-1181	1
SEAL-OIL,MHSA25 42 6 (Ref # 92049A)	92049-1314	1
COLLAR,SWING ARM,L=12.5 (Ref # 92143)	92143-1227	1
W-PLAIN-S (Ref # 410)	410E1000	2
BEARING-BALL,#6004 (Ref # 601)	601A6004	1