

2023 KX™ 85 PARTS DIAGRAM

Cables

F2540

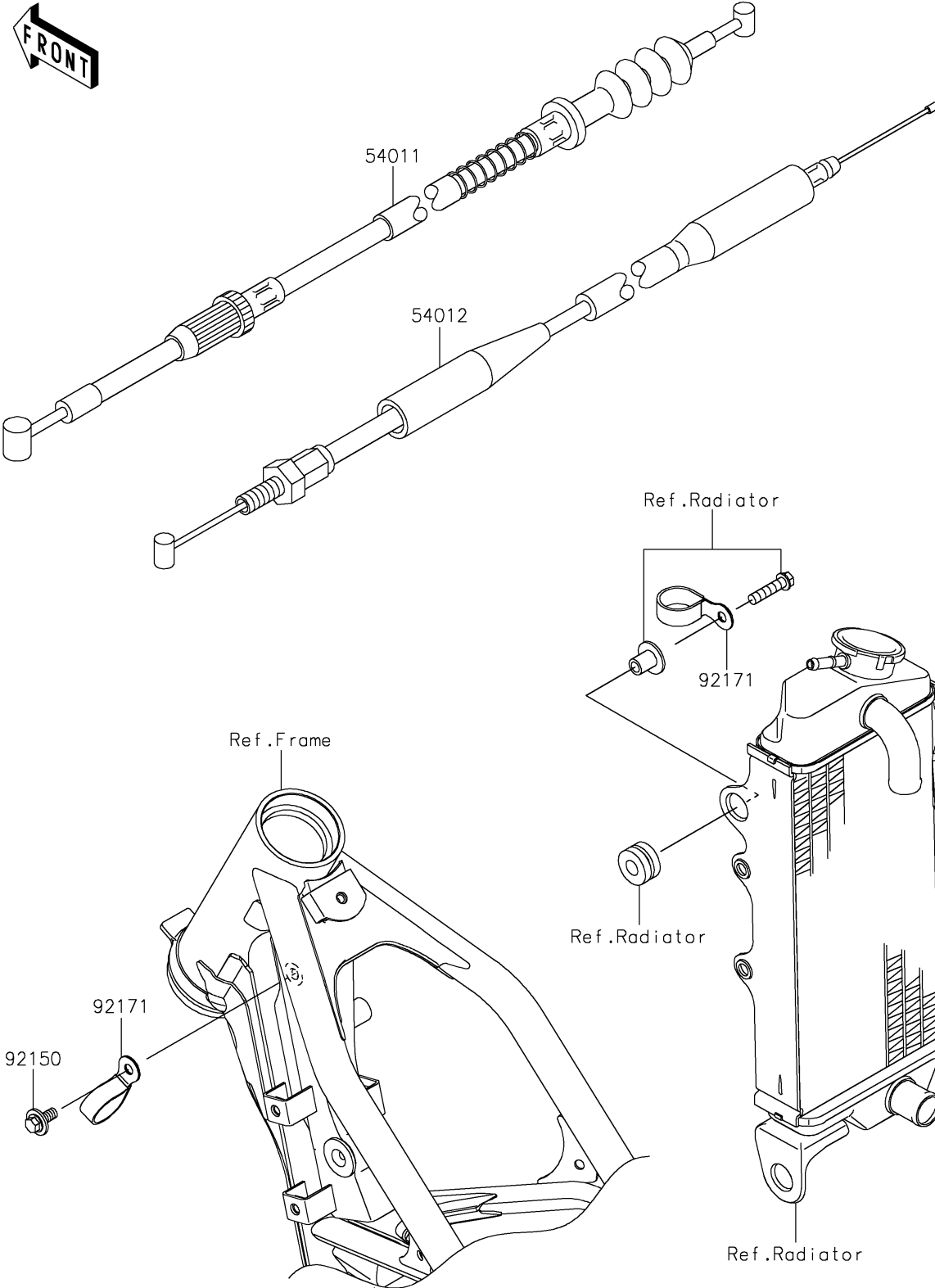

2023 KX™85 PARTS LIST

Cables

ITEM NAME	PART NUMBER	QUANTITY
CABLE-CLUTCH (Ref # 54011)	54011-0572	1
CABLE-THROTTLE (Ref # 54012)	54012-0595	1
BOLT,6X14 (Ref # 92150)	92150-1340	1
CLAMP (Ref # 92171)	92171-1279	2