

2023 KX™ 85 PARTS DIAGRAM

Handlebar

F2310

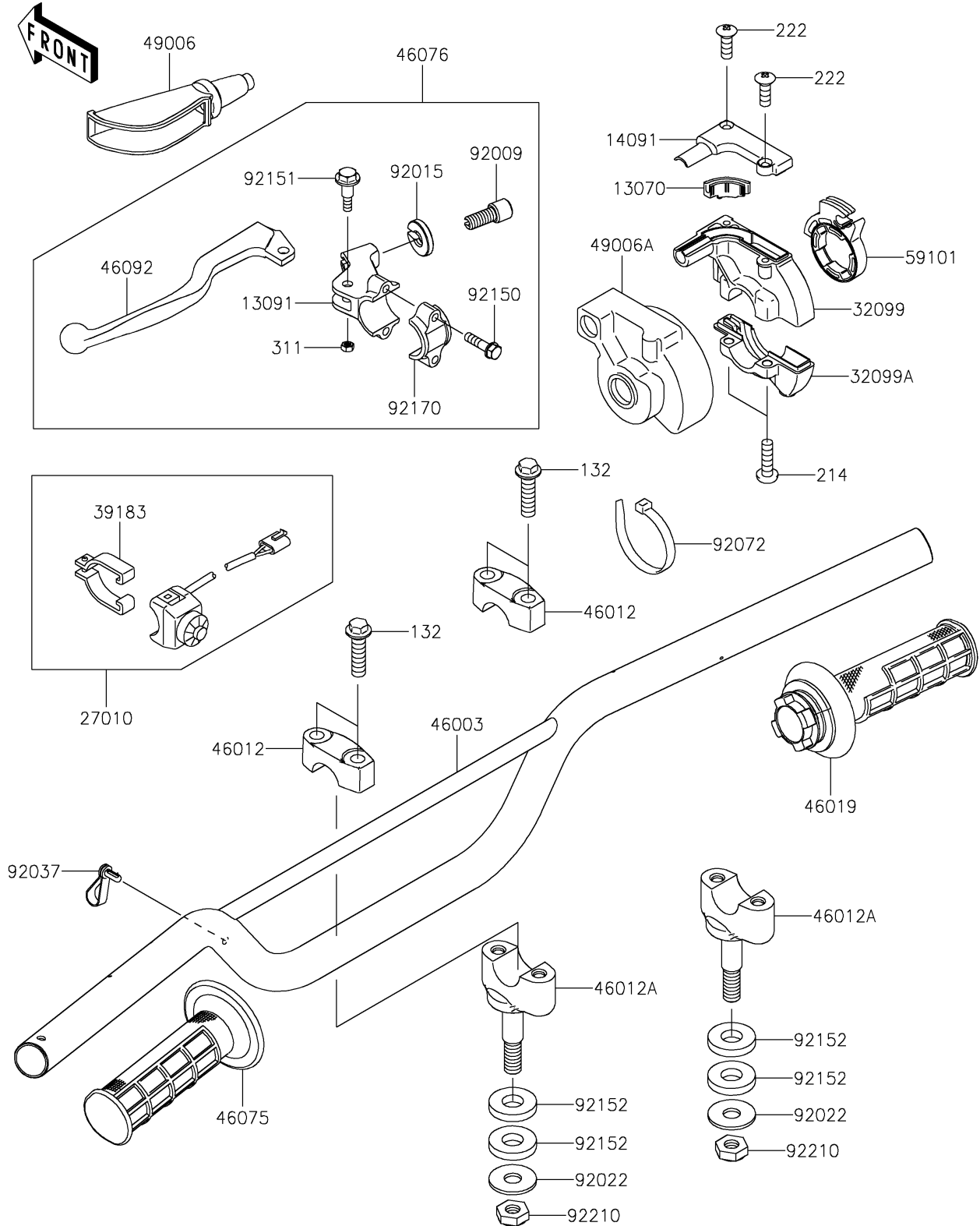

2023 KX™ 85 PARTS LIST

Handlebar

ITEM NAME	PART NUMBER	QUANTITY
GUIDE,THROTTLE (Ref # 13070)	13070-0083	1
HOLDER,CLUTCH LEVER (Ref # 13091)	13091-1728	1
COVER,THROTTLE CASE,UPP (Ref # 14091)	14091-0873	1
SWITCH,ENGINE STOP (Ref # 27010)	27010-0047	1
CASE,THROTTLE,UPP (Ref # 32099)	32099-0037	1
CASE,THROTTLE,LWR (Ref # 32099A)	32099-0038	1
BAND-ASSY,SWITCH (Ref # 39183)	39183-1059	1
HANDLE,F.S.BLACK (Ref # 46003)	46003-0205-18R	1
HOLDER-HANDLE,UPP,F.BLACK (Ref # 46012)	46012-0011-21	2
HOLDER-HANDLE,LWR,F.BLACK (Ref # 46012A)	46012-0342-21	2
GRIP-ASSY,THROTTLE (Ref # 46019)	46019-0023	1
GRIP,LH (Ref # 46075)	46075-0072	1
LEVER-ASSY-GRIP,CLUTCH (Ref # 46076)	46076-1203	1
LEVER-GRIP,CLUTCH (Ref # 46092)	46092-1165	1
BOOT,LEVER HOLDER (Ref # 49006)	49006-1017	1
BOOT,THROTTLE CASE (Ref # 49006A)	49006-1097	1
REEL,THROTTLE (Ref # 59101)	59101-0003	1
SCREW,CABLE ADJUST,8MM (Ref # 92009)	92009-1476	1
NUT,CABLE ADJUST LOCK,8MM (Ref # 92015)	92015-1596	1
WASHER,10.2X28X2 (Ref # 92022)	92022-1088	2
CLAMP,SPEED,L=58 (Ref # 92037)	92037-1163	1
BAND,L=100 (Ref # 92072)	92072-0055	1
BOLT (Ref # 92150)	92150-1474	2
BOLT,LEVER SET,5MM (Ref # 92151)	92151-1103	1
COLLAR,12.5X28X5 (Ref # 92152)	92152-1716	4
CLAMP,LEVER HOLDER (Ref # 92170)	92170-1226	1
NUT,LOCK,10MM (Ref # 92210)	92210-1184	2
BOLT-FLANGED-SMALL,8X35 (Ref # 132)	132BA0835	4
SCREW-PAN+-,5X18 (Ref # 214)	214AB0518	2

2023 KX™ 85 PARTS LIST

Handlebar

ITEM NAME	PART NUMBER	QUANTITY
SCREW-CSK-RD-CROS,4X12 (Ref # 222)	222AB0412	2
NUT-HEX,5MM (Ref # 311)	311AA0500	1