

2022 KX™112 PARTS DIAGRAM

Accessory

F2910

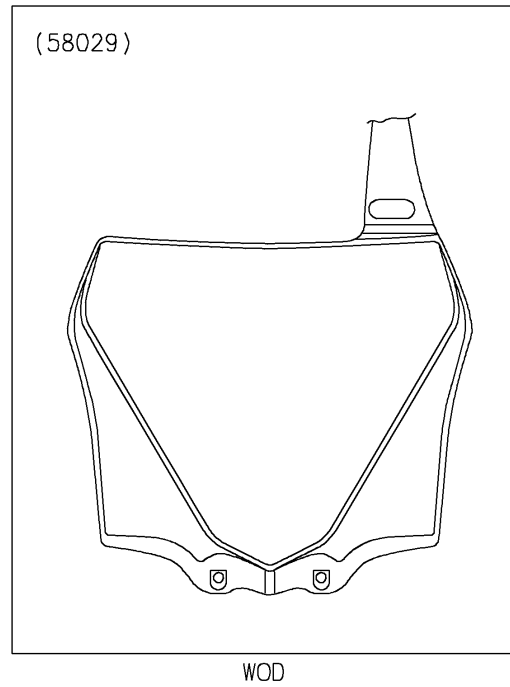
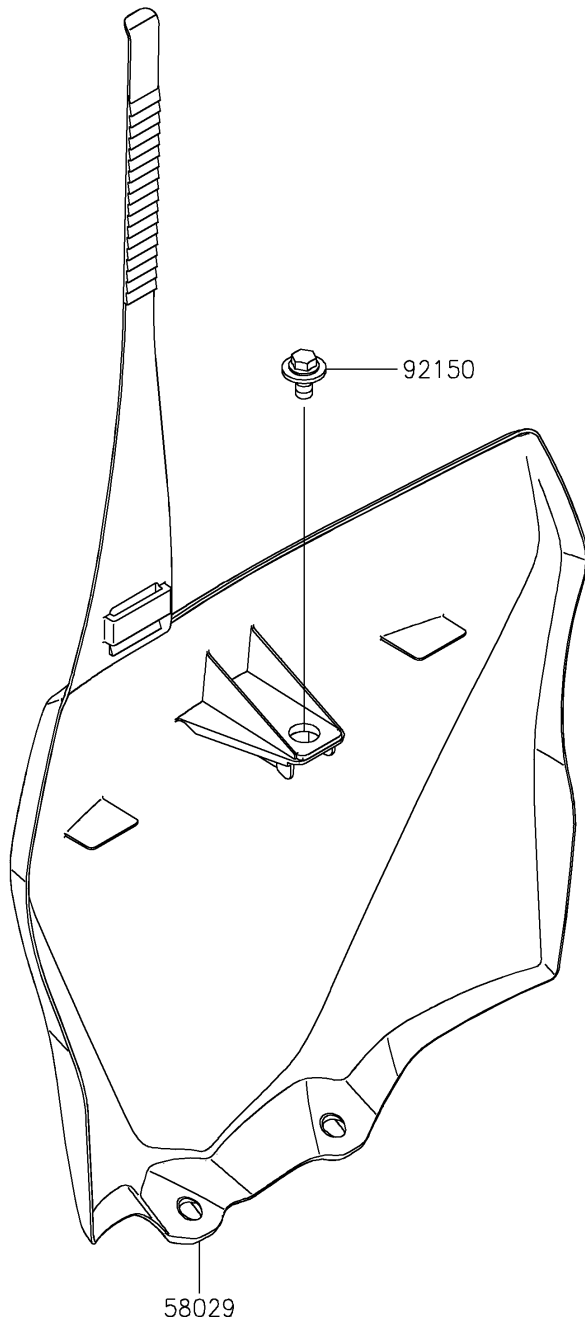

2022 KX™112 PARTS LIST

Accessory

ITEM NAME	PART NUMBER	QUANTITY
PLATE-NUMBER,L.GREEN (Ref # 58029)	58029-0011-290	1
BOLT,6X12 (Ref # 92150)	92150-1435	1