

1989 Ninja® ZX™-10 PARTS DIAGRAM

Rear Wheel/Chain

F2240-0218

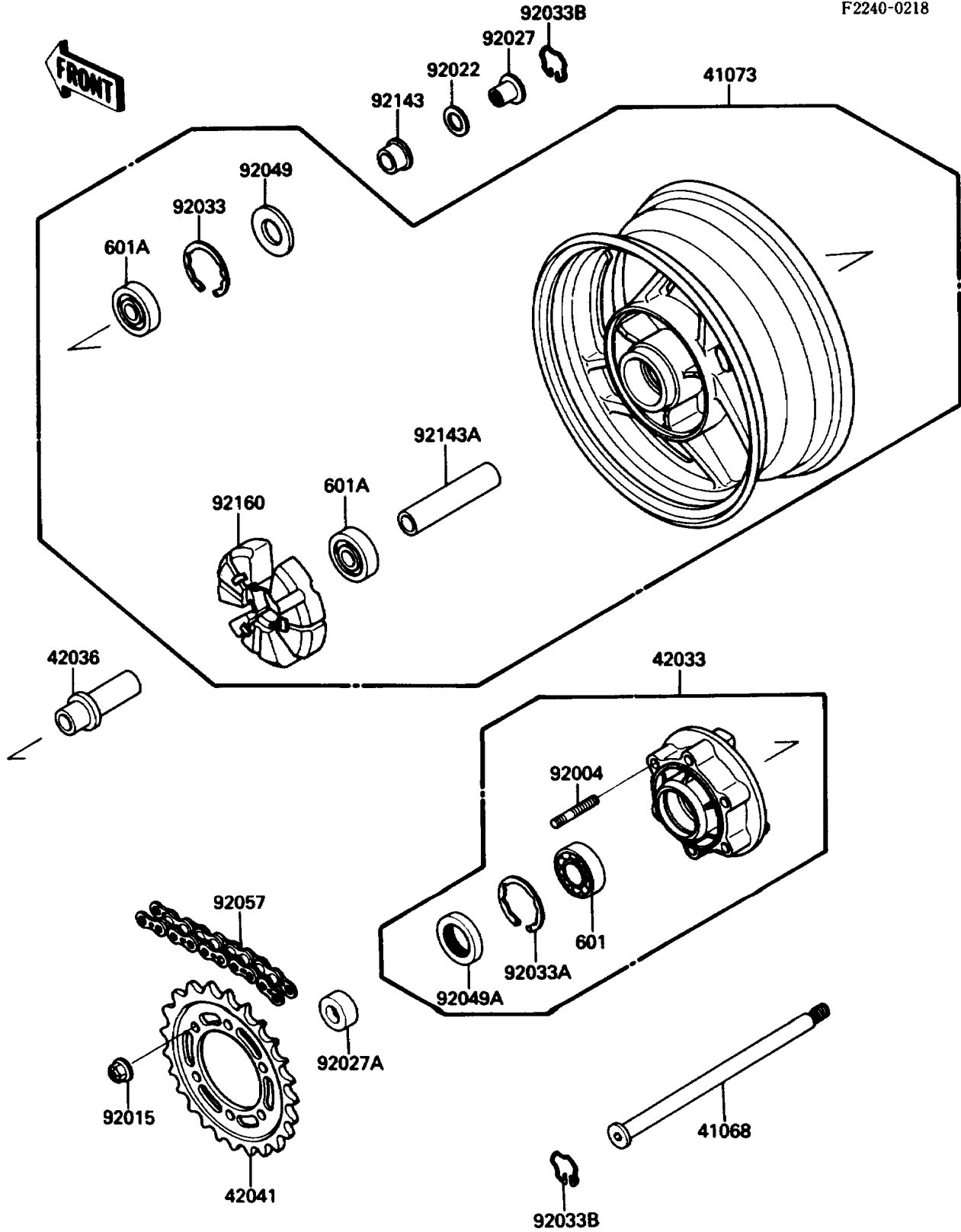

1989 Ninja® ZX™-10 PARTS LIST

Rear Wheel/Chain

ITEM NAME	PART NUMBER	QUANTITY
BEARING-BALL,#6206UUC3 (Ref # 601)	601B6206UU	1
BEARING-BALL,#6304UUC3 (Ref # 601A)	601B6304UU	2
AXLE,RR (Ref # 41068)	41068-1256	1
WHEEL-ASSY,RR,SILVER NO.1 (Ref # 41073)	41073-1392-CX	1
COUPLING-ASSY,RR HUB,M.SILVER (Ref # 42033)	42033-1133-7J	1
SLEEVE,RR AXLE,L=62 (Ref # 42036)	42036-1229	1
SPROCKET-HUB,45T (Ref # 42041)	42041-1306	1
STUD,10X24 (Ref # 92004)	92004-1146	6
NUT,10MM (Ref # 92015)	92015-1720	6
WASHER,23X32X2.3 (Ref # 92022)	92022-1618	1
COLLAR,RR AXLE,L=28 (Ref # 92027)	92027-1810	1
COLLAR,RR AXLE,L=20.5 (Ref # 92027A)	92027-1884	1
RING-SNAP,52MM (Ref # 92033)	92033-1043	1
RING-SNAP,62MM (Ref # 92033A)	92033-1044	1
RING-SNAP,RR AXLE (Ref # 92033B)	92033-1156	2
SEAL-OIL,28X52X5 (Ref # 92049)	92049-1061	1
SEAL-OIL,AJN40627 (Ref # 92049A)	92050-027	1
CHAIN,DRIVE,EK532ZV-OX110L (Ref # 92057)	92057-1259	1
COLLAR,L=23 (Ref # 92143)	92143-1042	1
COLLAR,20.2X29X89 (Ref # 92143A)	92143-1199	1
DAMPER,SHOCK,RR HUB (Ref # 92160)	92160-1051	1