

# 2009 KX™ 250F PARTS DIAGRAM

Valve(s)

E1210

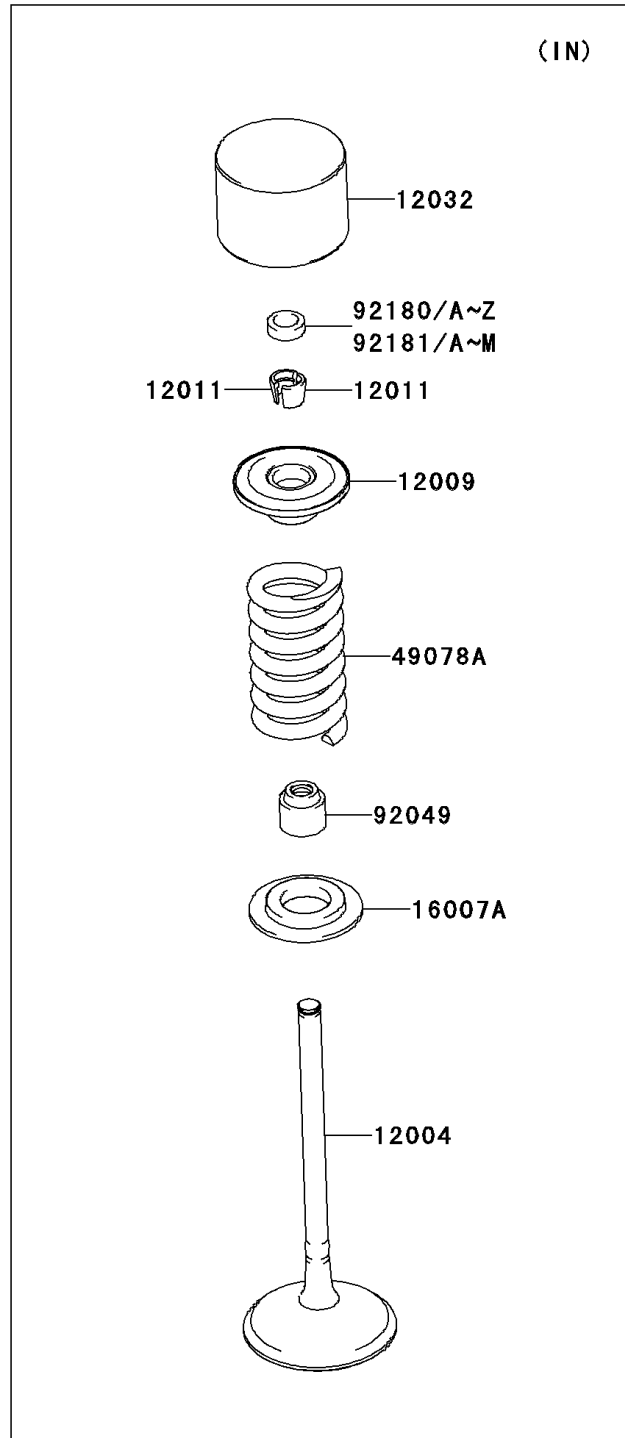
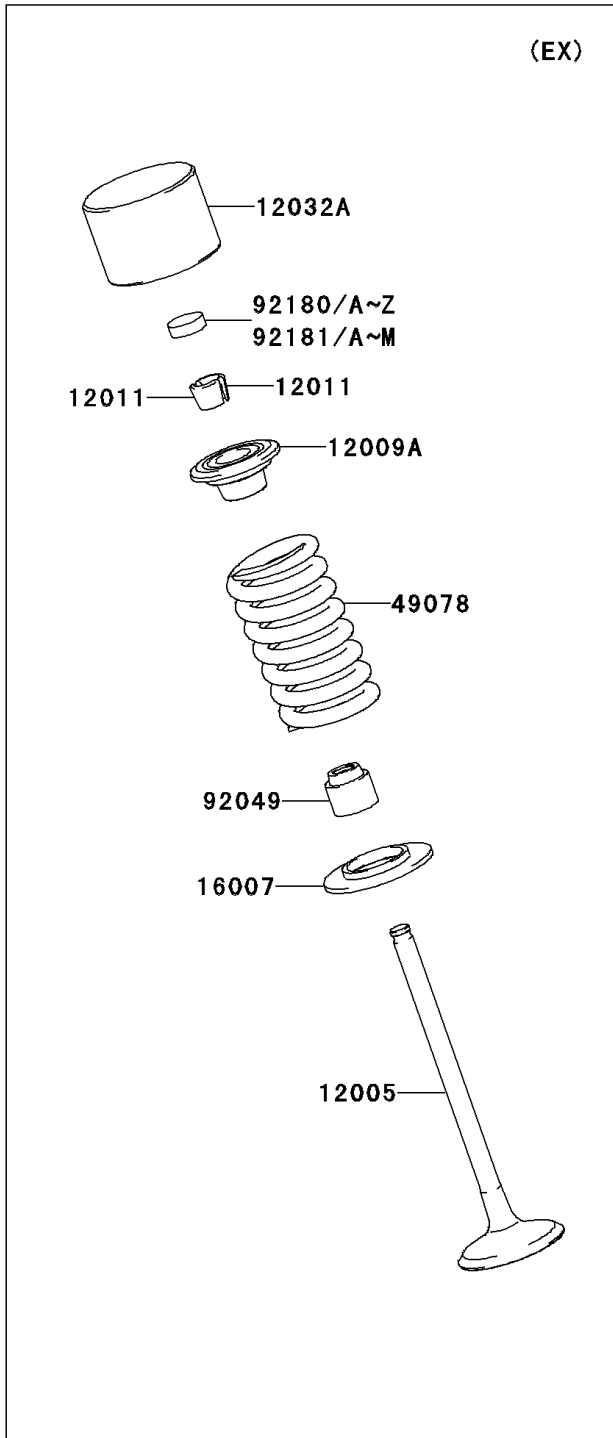

## 2009 KX™ 250F PARTS LIST

Valve(s)

ITEM NAME	PART NUMBER	QUANTITY
VALVE-INTAKE (Ref # 12004)	12004-0033	2
VALVE-EXHAUST (Ref # 12005)	12005-0002	2
RETAINER-VALVE SPRING (Ref # 12009)	12009-0010	2
RETAINER-VALVE SPRING (Ref # 12009A)	12009-1073	2
COLLET (Ref # 12011)	12011-1053	8
TAPPET,IN (Ref # 12032)	12032-0005	2
TAPPET,EX (Ref # 12032A)	12032-0006	2
SEAT-SPRING (Ref # 16007)	16007-0002	2
SEAT-SPRING (Ref # 16007A)	16007-0029	2
SPRING-ENGINE VALVE (Ref # 49078)	49078-0003	2
SPRING-ENGINE VALVE (Ref # 49078A)	49078-0056	2
SEAL-OIL,VSB 4.3 7.5 5.3 8.3 (Ref # 92049)	92049-1349	4
SHIM,T=2.500 (Ref # 92180)	92180-0167	4
SHIM,T=2.525 (Ref # 92180A)	92180-0168	AR
SHIM,T=2.550 (Ref # 92180B)	92180-0169	AR
SHIM,T=2.575 (Ref # 92180C)	92180-0170	AR
SHIM,T=2.600 (Ref # 92180D)	92180-0171	AR
SHIM,T=2.625 (Ref # 92180E)	92180-0172	AR
SHIM,T=2.650 (Ref # 92180F)	92180-0173	AR
SHIM,T=2.675 (Ref # 92180G)	92180-0174	AR
SHIM,T=2.700 (Ref # 92180H)	92180-0175	AR
SHIM,T=2.725 (Ref # 92180I)	92180-0176	AR
SHIM,T=2.750 (Ref # 92180J)	92180-0177	AR
SHIM,T=2.775 (Ref # 92180K)	92180-0178	AR
SHIM,T=2.800 (Ref # 92180L)	92180-0179	AR
SHIM,T=2.825 (Ref # 92180M)	92180-0180	AR
SHIM,T=2.850 (Ref # 92180N)	92180-0181	AR
SHIM,T=2.875 (Ref # 92180O)	92180-0182	AR
SHIM,T=2.900 (Ref # 92180P)	92180-0183	AR

## 2009 KX™ 250F PARTS LIST

Valve(s)

ITEM NAME	PART NUMBER	QUANTITY
SHIM,T=2.925 (Ref # 92180Q)	92180-0184	AR
SHIM,T=2.950 (Ref # 92180R)	92180-0185	AR
SHIM,T=2.975 (Ref # 92180S)	92180-0186	AR
SHIM,T=3.000 (Ref # 92180T)	92180-0187	AR
SHIM,T=3.025 (Ref # 92180U)	92180-0188	AR
SHIM,T=3.050 (Ref # 92180V)	92180-0189	AR
SHIM,T=3.075 (Ref # 92180W)	92180-0190	AR
SHIM,T=3.100 (Ref # 92180X)	92180-0191	AR
SHIM,T=3.125 (Ref # 92180Y)	92180-0192	AR
SHIM,T=3.150 (Ref # 92180Z)	92180-0193	AR
SHIM,T=3.175 (Ref # 92181)	92180-0194	AR
SHIM,T=3.200 (Ref # 92181A)	92180-0195	AR
SHIM,T=3.225 (Ref # 92181B)	92180-0196	AR
SHIM,T=3.250 (Ref # 92181C)	92180-0197	AR
SHIM,T=3.275 (Ref # 92181D)	92180-0198	AR
SHIM,T=3.300 (Ref # 92181E)	92180-0199	AR
SHIM,T=3.325 (Ref # 92181F)	92180-0200	AR
SHIM,T=3.350 (Ref # 92181G)	92180-0201	AR
SHIM,T=3.375 (Ref # 92181H)	92180-0202	AR
SHIM,T=3.400 (Ref # 92181I)	92180-0203	AR
SHIM,T=3.425 (Ref # 92181J)	92180-0204	AR
SHIM,T=3.450 (Ref # 92181K)	92180-0205	AR
SHIM,T=3.475 (Ref # 92181L)	92180-0206	AR
SHIM,T=3.500 (Ref # 92181M)	92180-0207	AR