

2024 MULE™ 4010 TRANS4x4® FE

PARTS DIAGRAM

Throttle

E1510

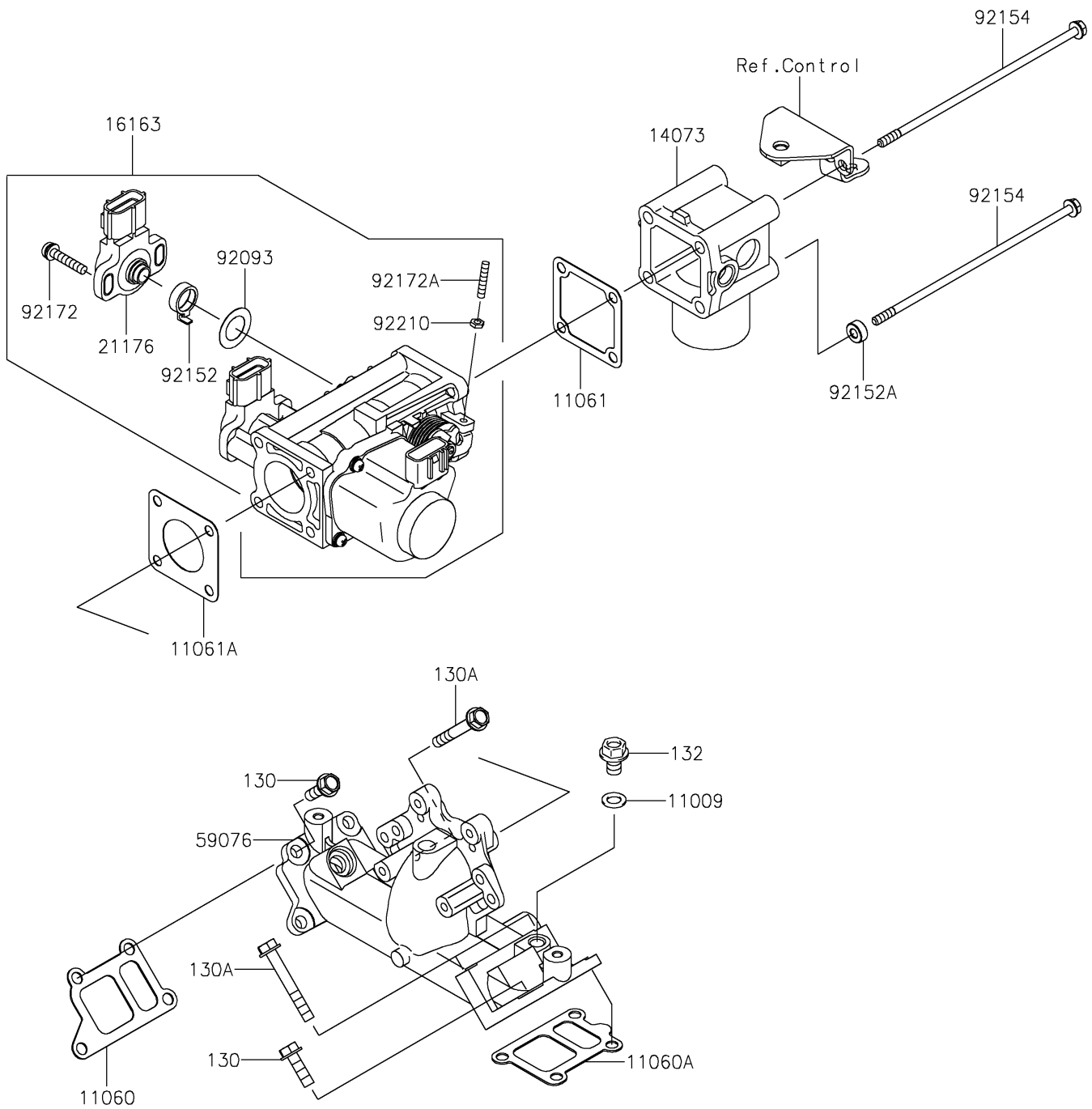

2024 MULE™ 4010 TRANS4x4® FE

PARTS LIST

Throttle

ITEM NAME	PART NUMBER	QUANTITY
GASKET,8.2X14X1.0 (Ref # 11009)	11009-1344	1
GASKET,INTAKE MANIFOLD (Ref # 11060)	11060-2087	1
GASKET,INTAKE MANIFOLD (Ref # 11060A)	11060-2088	1
GASKET (Ref # 11061)	11061-0861	1
GASKET (Ref # 11061A)	11061-2179	1
DUCT (Ref # 14073)	14073-0780	1
THROTTLE-ASSY (Ref # 16163)	16163-0949	1
SENSOR (Ref # 21176)	21176-2112	1
MANIFOLD-INTAKE (Ref # 59076)	59076-0718	1
SEAL (Ref # 92093)	92093-2133	1
COLLAR (Ref # 92152)	92152-2093	1
COLLAR,LWR SIDE (Ref # 92152A)	92152-2333	2
BOLT,FLANGED,6X195 (Ref # 92154)	92154-2653	4
SCREW (Ref # 92172)	92172-0254	2
SCREW (Ref # 92172A)	92172-2106	1
NUT (Ref # 92210)	92210-2120	1
BOLT-FLANGED,6X20 (Ref # 130)	130BA0620	5
BOLT-FLANGED,6X45 (Ref # 130A)	130CA0645	3
BOLT-FLANGED-SMALL,8X12 (Ref # 132)	132BB0812	1