

# 1991 Zephyr PARTS DIAGRAM

Side Cover/Chain Case(ZR550-B1/B2)

F2610

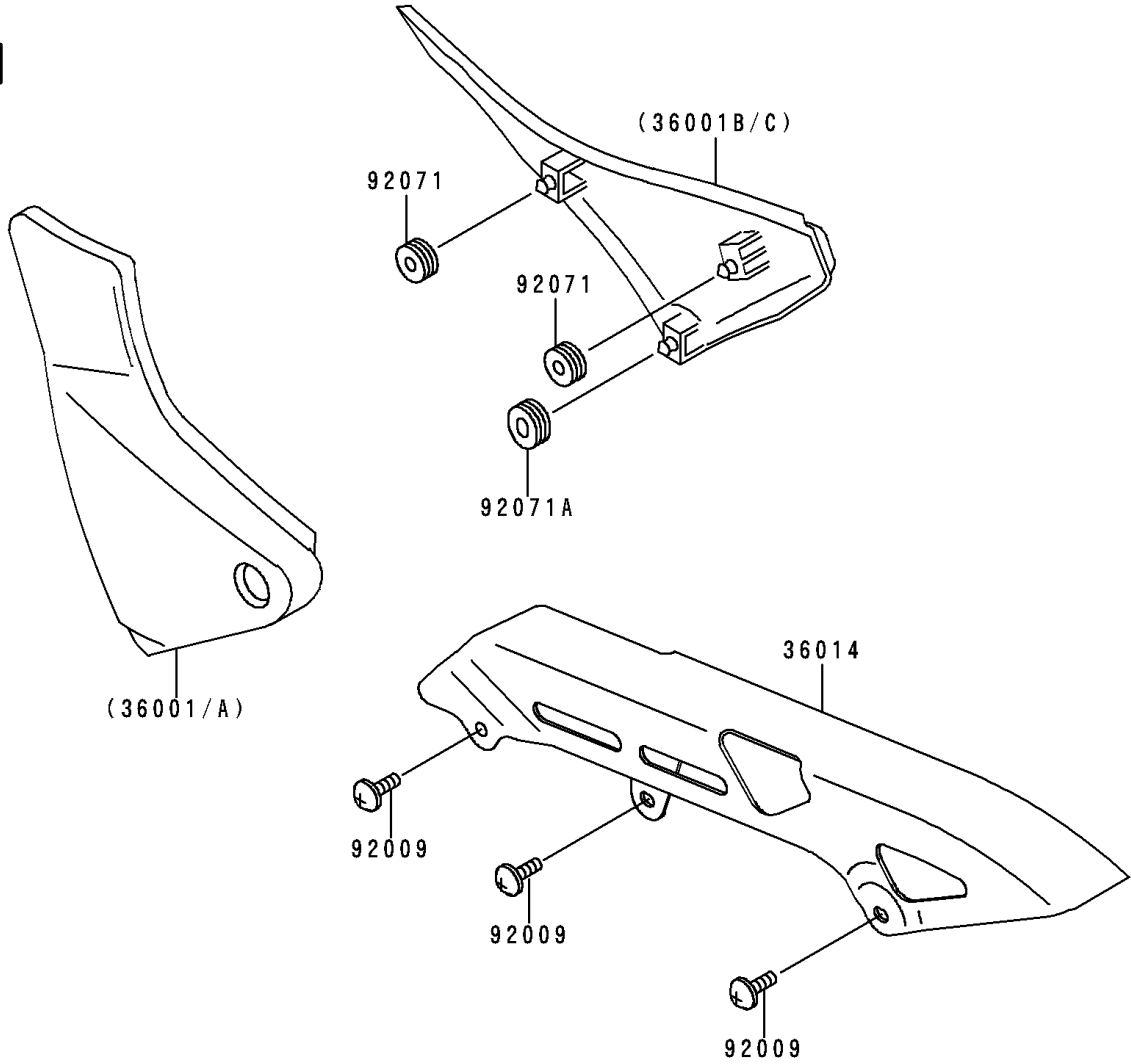

36001/B

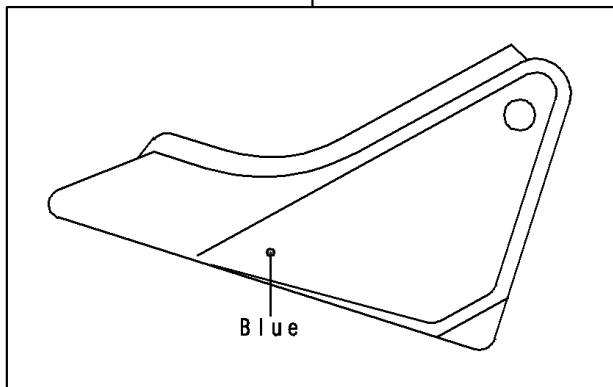

36001A/C

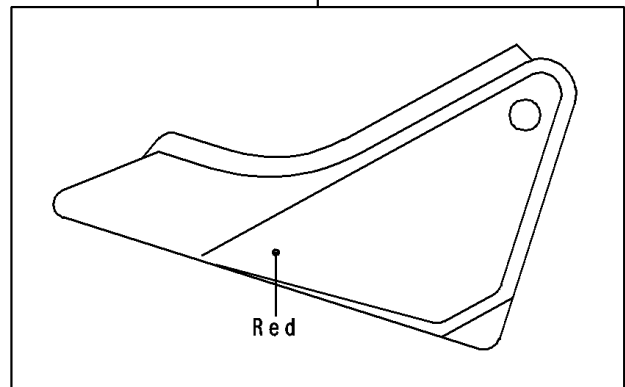

# 1991 Zephyr PARTS LIST

Side Cover/Chain Case(ZR550-B1/B2)

ITEM NAME	PART NUMBER	QUANTITY
COVER-SIDE,LH,C.A.BLUE (Ref # 36001)	36001-1422-FC	1
COVER-SIDE,LH,C.C.RED (Ref # 36001A)	36001-1422-L1	1
COVER-SIDE,RH,C.A.BLUE (Ref # 36001B)	36001-1423-FC	1
COVER-SIDE,RH,C.C.RED (Ref # 36001C)	36001-1423-L1	1
CASE-CHAIN (Ref # 36014)	36014-1161	1
SCREW,6X10,WHITE (Ref # 92009)	92009-1286	3
GROMMET (Ref # 92071)	92071-056	4
GROMMET (Ref # 92071A)	92071-1043	2