

# 1991 Zephyr PARTS DIAGRAM

Camshaft/Tensioner

E1230

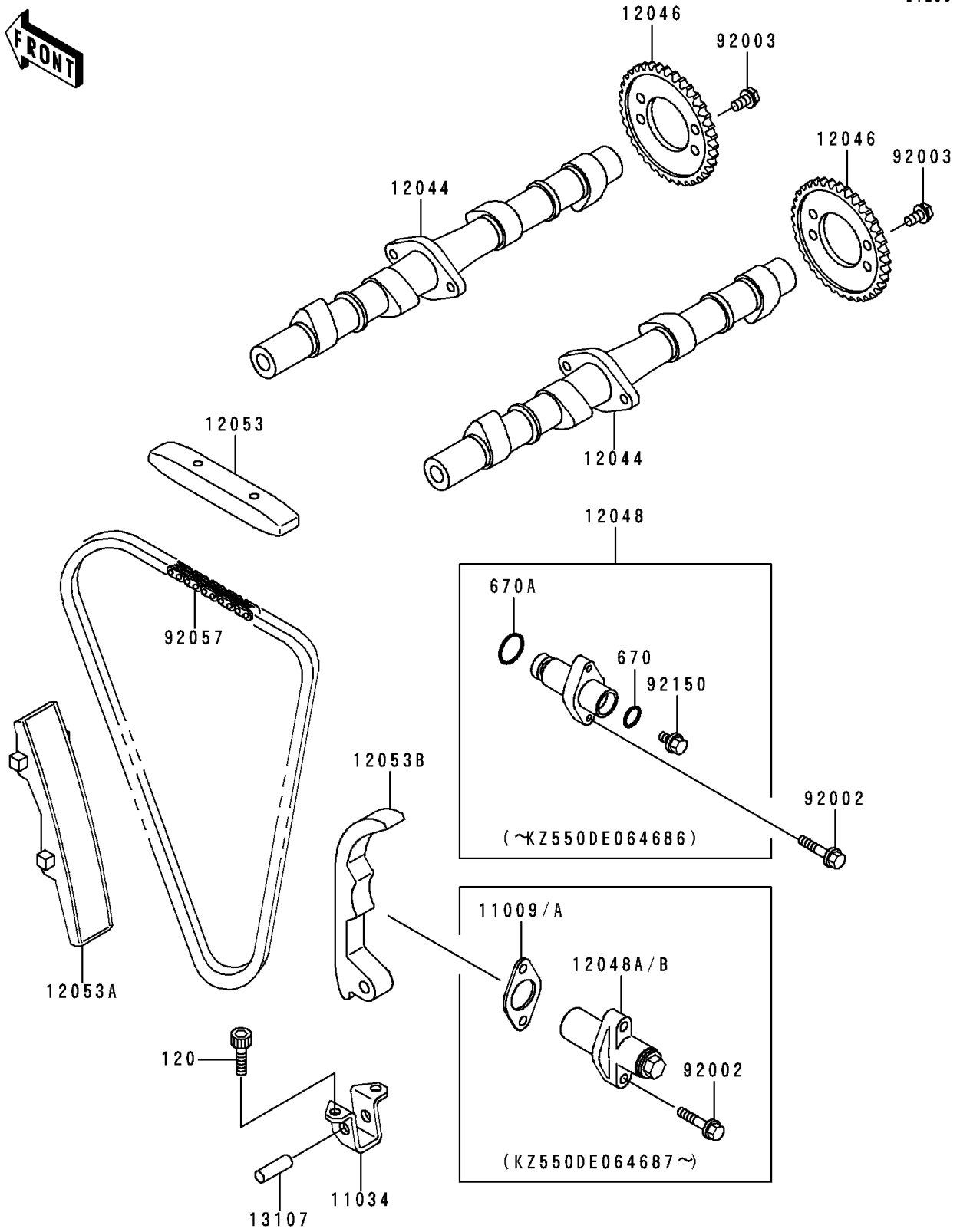

# 1991 Zephyr PARTS LIST

## Camshaft/Tensioner

ITEM NAME	PART NUMBER	QUANTITY
BOLT-SOCKET,6X18 (Ref # 120)	120P0618	2
O RING (Ref # 670)	670D2010	1
O RING,21MM (Ref # 670A)	670D2021	1
GASKET,TENSIONER (Ref # 11009A)	11009-1858	1
BRACKET,CHAIN GUIDE (Ref # 11034)	11034-1240	1
CAMSHAFT-VALVE (Ref # 12044)	12044-1034	2
SPROCKET,CAMSHAFT,42T (Ref # 12046)	12046-1019	2
TENSIONER-ASSY,CAM CHAIN (Ref # 12048)	12048-1066	1
TENSIONER-ASSY,CAM CHAIN (Ref # 12048B)	12048-1111	1
GUIDE-CHAIN,CAM,HEAD (Ref # 12053)	12053-1018	1
GUIDE-CHAIN,CAM,FR (Ref # 12053A)	12053-1022	1
GUIDE-CHAIN,CAM,RR (Ref # 12053B)	12053-1113	1
SHAFT,8X25 (Ref # 13107)	13107-1142	1
BOLT,6X25 (Ref # 92002)	92002-1086	2
BOLT,FLANGED,6X11 (Ref # 92003)	92003-208	4
CHAIN,CAM,82RH2015-140L (Ref # 92057)	92057-1290	1
BOLT,TENSIONER (Ref # 92150)	92150-1380	1