

2011 Mule 4010 Trans4x4 PARTS DIAGRAM

Engine Mount

F2122

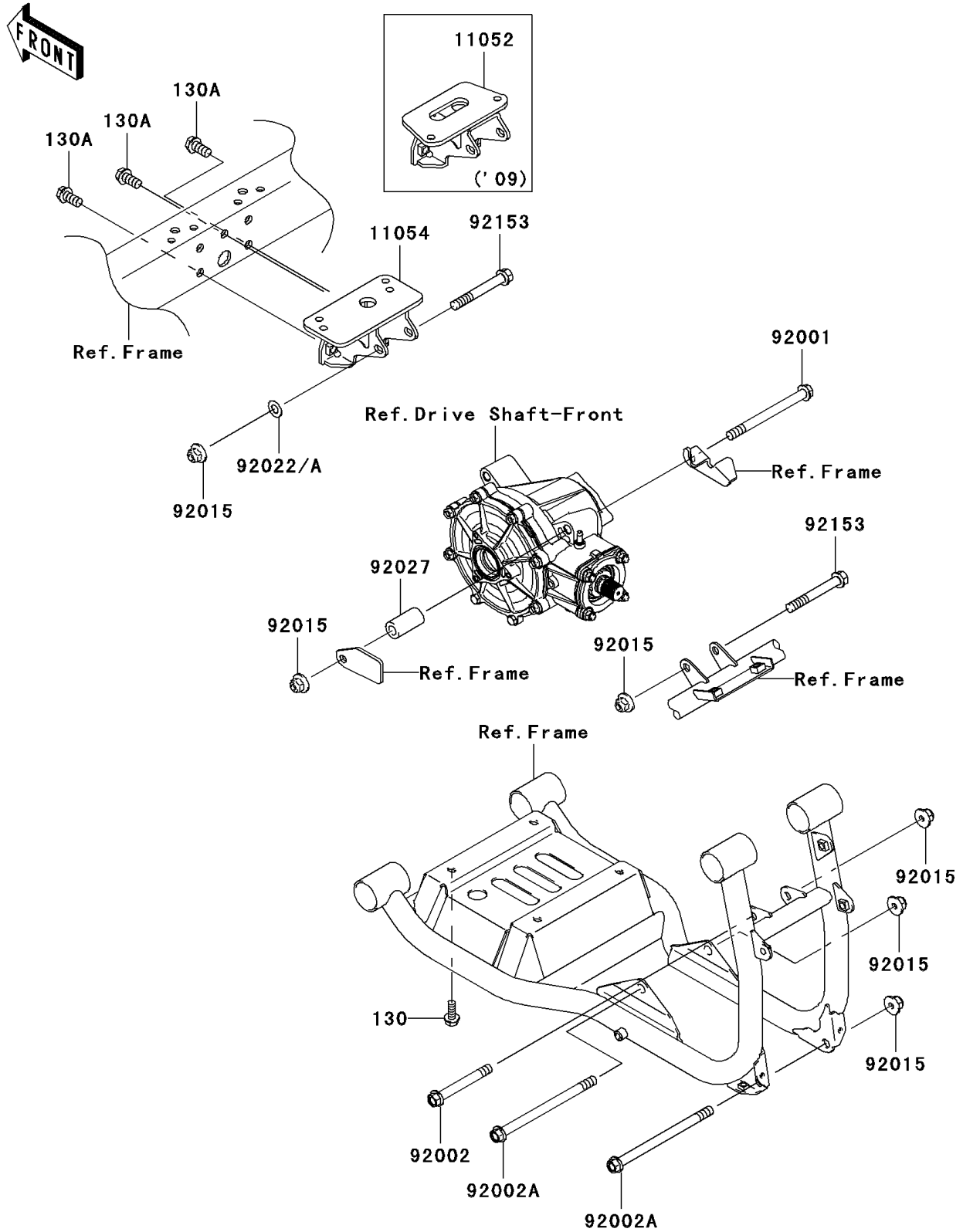

2011 Mule 4010 Trans4x4 PARTS LIST

Engine Mount

ITEM NAME	PART NUMBER	QUANTITY
BRACKET,FRONT GEAR CASE (Ref # 11054)	11054-7506	1
BOLT,FLANGED,10X115 (Ref # 92001)	92001-1603	1
BOLT,FLANGED,10X80 (Ref # 92002)	92002-1764	1
BOLT,FLANGED,10X145 (Ref # 92002A)	92002-1765	2
NUT,LOCK,10MM (Ref # 92015)	92015-1597	6
WASHER,10.2X20X0.5 (Ref # 92022)	92022-1649	AR
WASHER,10.5X20X1 (Ref # 92022A)	92022-239	AR
COLLAR,11X20X39 (Ref # 92027)	92027-1518	1
BOLT,FLANGED,10X75 (Ref # 92153)	92153-1384	2
BOLT-FLANGED,8X20 (Ref # 130)	130BA0820	4
BOLT-FLANGED,10X20 (Ref # 130A)	130BA1020	3