

2013 MULE™ 4010 TRANS4x4® DIESEL PARTS DIAGRAM

Crankcase

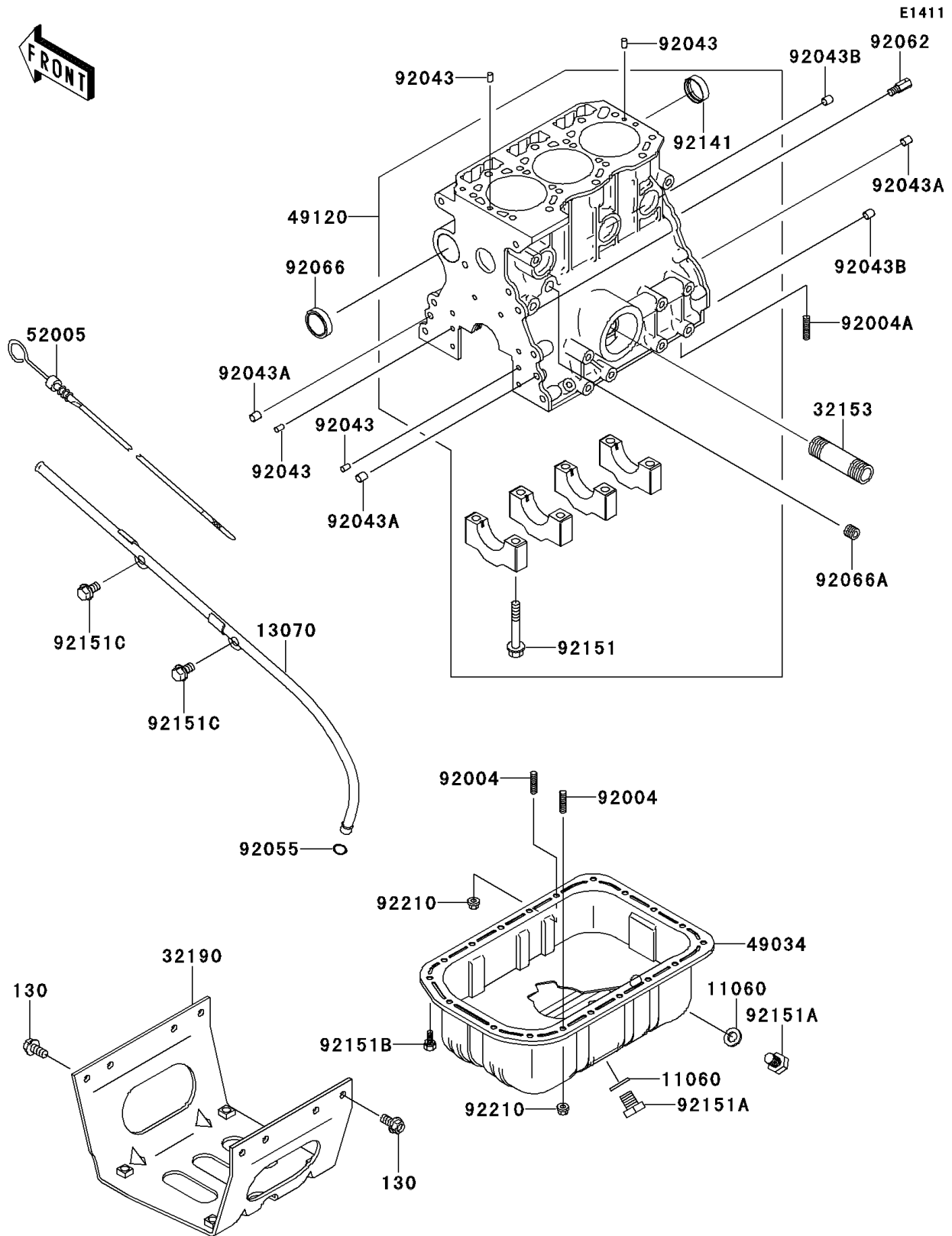

2013 MULE™ 4010 TRANS4x4® DIESEL PARTS LIST

Crankcase

ITEM NAME	PART NUMBER	QUANTITY
GASKET,OIL DRAIN BOLT (Ref # 11060)	11060-1942	2
GUIDE,GAUGE (Ref # 13070)	13070-1350	1
PIPE,OIL FILTER (Ref # 32153)	32153-1355	1
BRACKET-ENGINE (Ref # 32190)	32190-1187	1
PAN-OIL (Ref # 49034)	49034-0024	1
CRANKCASE-COMP (Ref # 49120)	49120-0008	1
GAUGE,OIL LEVEL (Ref # 52005)	52005-1139	1
STUD,6X10 (Ref # 92004)	92004-1261	2
STUD,6X14 (Ref # 92004A)	92004-1262	1
PIN,6MM (Ref # 92043)	92043-1609	4
PIN,8MM (Ref # 92043A)	92043-1610	3
PIN,8MM (Ref # 92043B)	92043-1611	2
RING-O (Ref # 92055)	92055-1625	1
NOZZLE (Ref # 92062)	92062-1088	1
PLUG (Ref # 92066)	92066-1526	1
PLUG,CRANKCASE (Ref # 92066A)	92066-1527	1
BUSHING,CRANKCASE (Ref # 92141)	92141-1053	1
BOLT,CRANKSHAFT (Ref # 92151)	92151-1655	8
BOLT,OIL DRAIN (Ref # 92151A)	92151-1656	2
BOLT,6X12 (Ref # 92151B)	92151-1657	17
BOLT,8X14 (Ref # 92151C)	92151-1658	2
NUT,6MM (Ref # 92210)	92210-1208	2
BOLT-FLANGED,8X16 (Ref # 130)	130BB0816	8