

2013 MULE™ 4010 TRANS4x4® DIESEL PARTS DIAGRAM

Driven Converter/Drive Belt

E1392

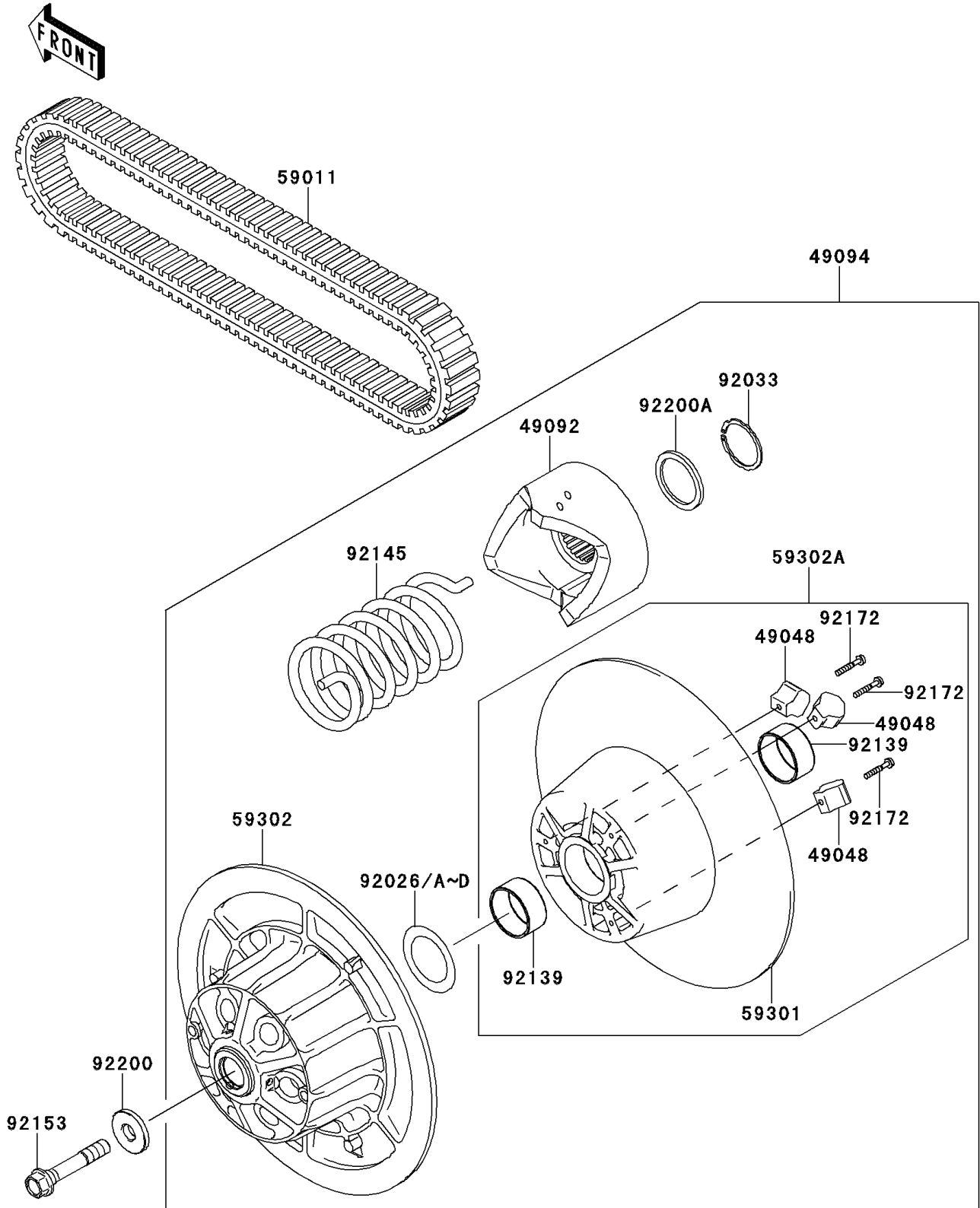

2013 MULE™ 4010 TRANS4x4® DIESEL PARTS LIST

Driven Converter/Drive Belt

ITEM NAME	PART NUMBER	QUANTITY
SHOE (Ref # 49048)	49048-1097	3
RAMP (Ref # 49092)	49092-1069	1
CONVERTER-ASSY-DRIVEN (Ref # 49094)	49094-0034	1
BELT (Ref # 59011)	59011-1087	1
SHEAVE-MOVABLE (Ref # 59301)	59301-1072	1
SHEAVE-COMP (Ref # 59302)	59302-0024	1
SHEAVE-COMP,MOVABLE (Ref # 59302A)	59302-1104	1
SPACER,40.5X58X0.3 (Ref # 92026)	92026-0036	AR
SPACER,40.5X58X1.0 (Ref # 92026A)	92026-1625	1
SPACER,40.5X58X0.6 (Ref # 92026B)	92026-1626	AR
SPACER,40.5X58X1.4 (Ref # 92026C)	92026-1627	AR
SPACER,40.5X58X0.8 (Ref # 92026D)	92026-1628	AR
RING-SNAP (Ref # 92033)	92033-1317	1
BUSHING (Ref # 92139)	92139-1078	2
SPRING,DRIVEN CONVERTER (Ref # 92145)	92145-0047	1
BOLT,12X70 (Ref # 92153)	92153-0509	1
SCREW,4X25 (Ref # 92172)	92172-0060	3
WASHER (Ref # 92200)	92200-0069	1
WASHER,40X46.4X2.5 (Ref # 92200A)	92200-1645	1