

# 2024 KX™ 450 PARTS DIAGRAM

Generator

E1810

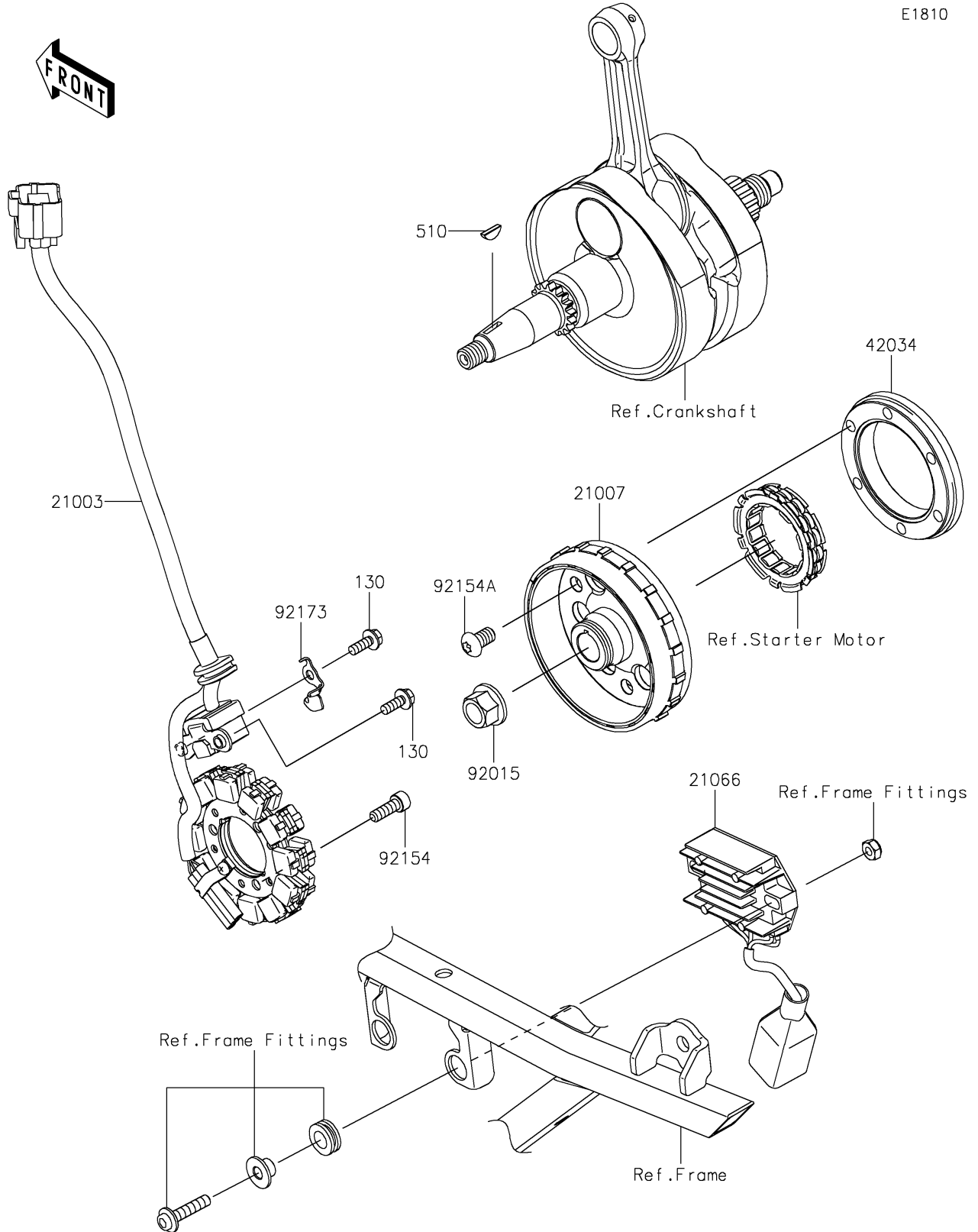

## 2024 KX™ 450 PARTS LIST

### Generator

ITEM NAME	PART NUMBER	QUANTITY
STATOR (Ref # 21003)	21003-0226	1
ROTOR (Ref # 21007)	21007-0732	1
REGULATOR-VOLTAGE (Ref # 21066)	21066-0797	1
COUPLING,ONEWEY CLUTCH (Ref # 42034)	42034-0757	1
NUT,12MM (Ref # 92015)	92015-1426	1
BOLT,SOCKET,6X18 (Ref # 92154)	92154-2947	3
BOLT,TORX,8X14 (Ref # 92154A)	92154-2994	6
CLAMP (Ref # 92173)	92173-1855	1
BOLT-FLANGED,5X14 (Ref # 130)	130BA0514	2
KEY-WOODRUFF (Ref # 510)	510A3200	1