

# 2022 KX™ 250 PARTS DIAGRAM

Swingarm

F2141

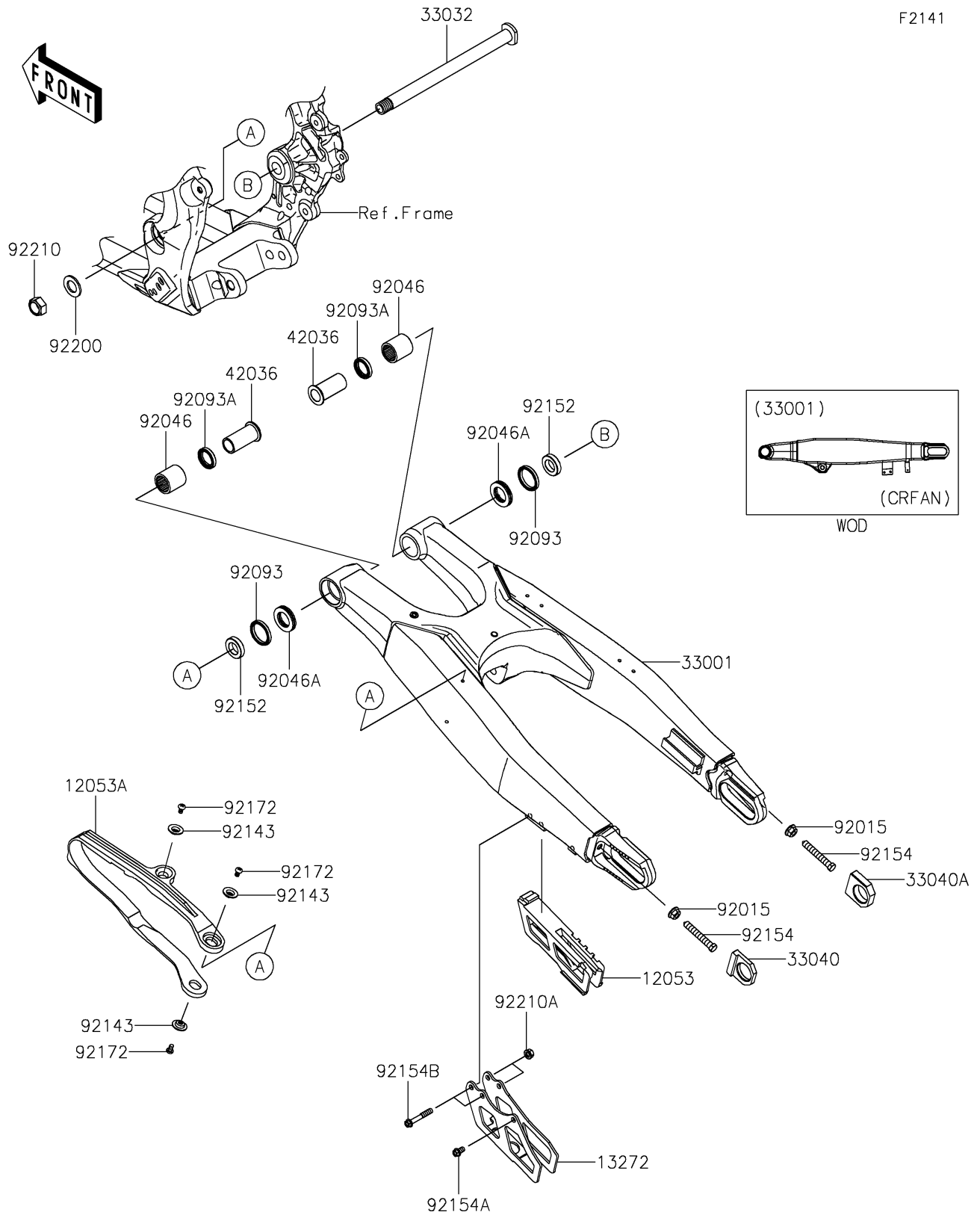

## 2022 KX™ 250 PARTS LIST

### Swingarm

ITEM NAME	PART NUMBER	QUANTITY
GUIDE-CHAIN (Ref # 12053)	12053-0125	1
GUIDE-CHAIN (Ref # 12053A)	12053-0254	1
PLATE,CHAIN GUARD (Ref # 13272)	13272-2485	1
ARM-COMP-SWING (Ref # 33001)	33001-0713	1
SHAFT-SWING ARM (Ref # 33032)	33032-0012	1
ADJUSTER-CHAIN,LH (Ref # 33040)	33040-0050	1
ADJUSTER-CHAIN,RH (Ref # 33040A)	33040-0080	1
SLEEVE,17X22X47.3 (Ref # 42036)	42036-0784	2
NUT,FLANGED,8MM (Ref # 92015)	92015-1014	2
BEARING-NEEDLE,TA2230Z (Ref # 92046)	92046-1174	2
BEARING-NEEDLE,NTBR22356E01 (Ref # 92046A)	92046-1240	2
SEAL,SDO29X35X4.5 (Ref # 92093)	92093-1434	2
SEAL,SDO22X29X5 (Ref # 92093A)	92093-1435	2
COLLAR (Ref # 92143)	92143-1676	3
COLLAR,17.1X29X6.7 (Ref # 92152)	92152-2222	2
BOLT,8X50 (Ref # 92154)	92154-2957	2
BOLT,6X10 (Ref # 92154A)	92154-2963	1
BOLT,6X40 (Ref # 92154B)	92154-2968	2
SCREW,5X8 (Ref # 92172)	92172-0119	3
WASHER,17.2X30X2.3 (Ref # 92200)	92200-0285	1
NUT,LOCK,16MM (Ref # 92210)	92210-0285	1
NUT,FLANGED,6MM (Ref # 92210A)	92210-0630	2